

BAIO[®] system & ZAK[®] system
Simple and time-saving joining technique
for installing pipelines and the service line sector

Explanatory notes on the brochure

General media information in the product descriptions may apply subject to certain restrictions. Kindly always state the relevant medium in your given application when you place an order or submit a query.

If you have any further questions about our products, please do not hesitate to contact our employees of the application engineering division at any time.



Products for use in connection with potable water



Products for use in municipal sewage treatment (www.hawle.de/grenzwerte-abwasser)



Products for use in connection with natural gas (in accordance with DVGW [German Association for Gas and Water] Technical Rule G 260)



Information on our “10-year quality guarantee” for Hawle potable water products are available at the following link: www.hawle.de/en/10-years-quality-warranty/



For current information, please see our Hawle app. Further information is available at www.hawle.de/en/downloads/hawle-app/hawle-app/

Advantages of threadless connection systems

For decades, the connection of pipes and pipe fittings in buried pipeline construction has been mainly effected by means of flangeless connections as this connection technology has both technical and economical advantages over conventional flanged and welded connections. In the past, threaded connections were used in the construction of service lines. The bare transition areas typical of this way of connection were susceptible to contact corrosion causing incrustation, which often permanently damaged the connection and the sealing.

Therefore, in the early 1980s, Hawle Armaturen GmbH developed the Hawle BAIO® system with a view to providing customers with a simple and stress-relieved installation of pipeline elements and valves, while simultaneously ensuring a long service life of the system due to integral corrosion protection.

This idea formed also the basis of the Hawle ZAK® system designed for the service line sector to achieve a long ser-

vice life of the service system in this regard, too. Meanwhile, both connection systems have become widely accepted as the state of the art.

These generally acknowledged advantages can be fully applied to the connection between pipelines and valves, as well as between valves. In addition to the technical advantages of the threadless connection system, the economic benefits of this push-fit socket technology deserve special mention. In the case of the Hawle BAIO® system, this results in savings from its compact design, which facilitates storage and transport, as well as from the considerably shorter installation times compared with conventional flanged and welded connections (see graphs, page 4-7).

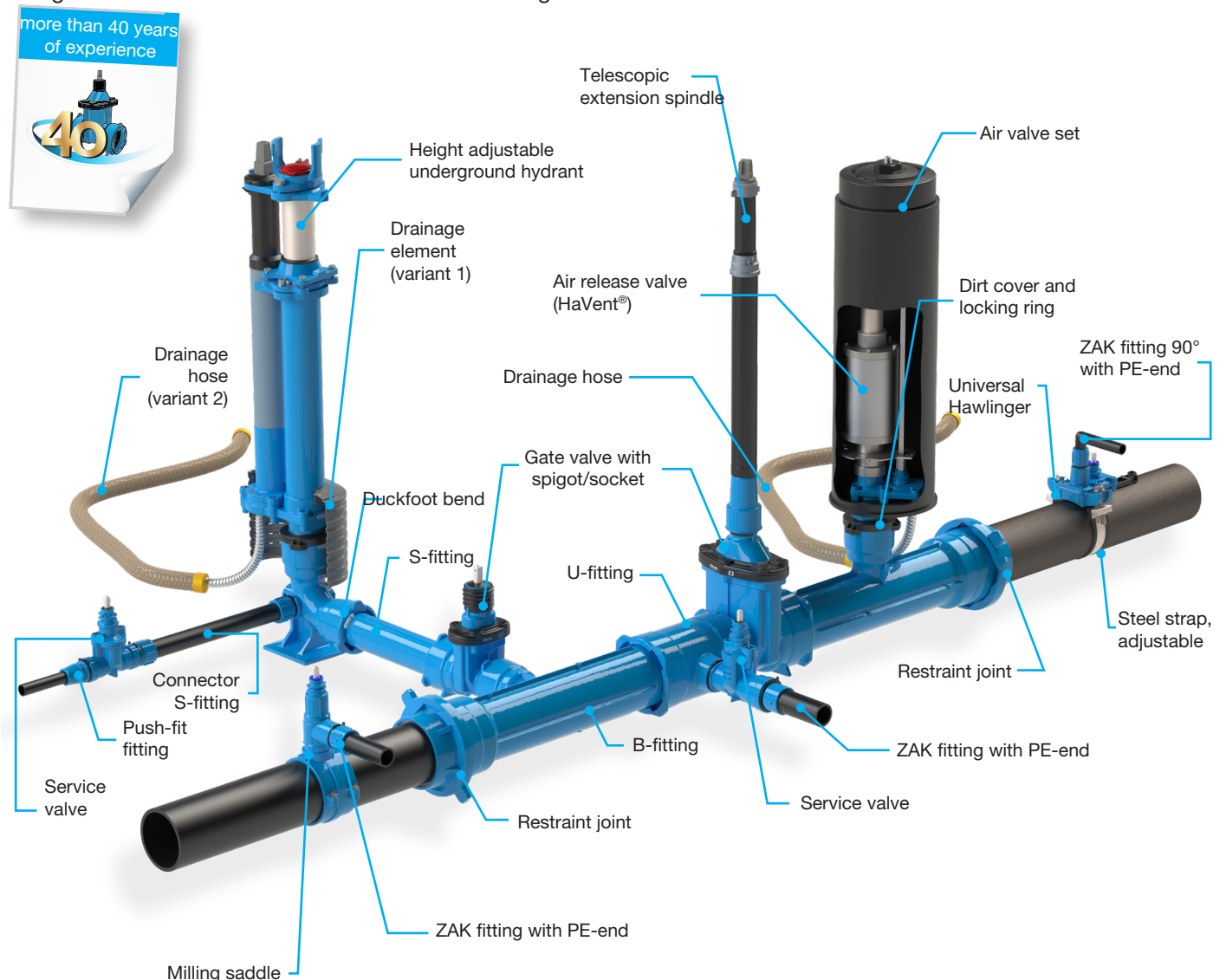

Technical features of the BAIO® system

A comparison of the BAIO® system with flanged fittings

BAIO® system: 5 components

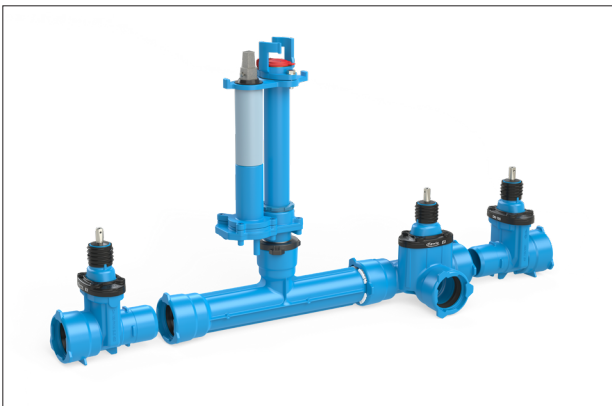

Flange system: 307 components

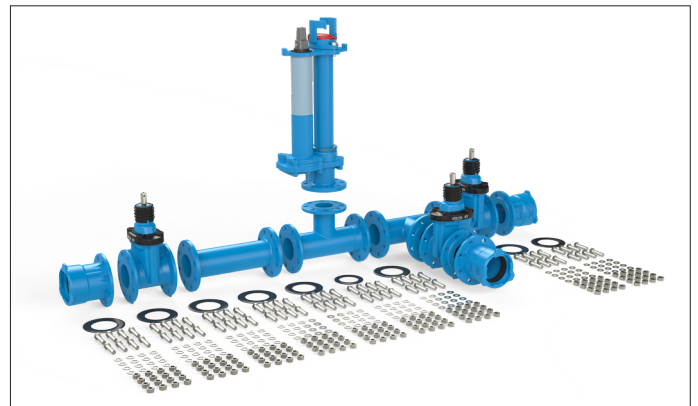

Technical features of the BAIO® system:

- Medium: potable water, sewage, gas (when ordering, please specify the medium and pipe type to ensure that the correct seal is supplied). Standard gasket: BAIO® lip seal for water. The gaskets are pre-assembled at the factory. Gas seals must be marked. Gaskets not marked may not be used for gas).
- Nominal diameters DN 80 - DN 300
- Max. operating pressure 16 bar
- Simple, time-saving installation
- A small number of components and connections*
- All-round flexible plug-in sleeve connection (up to 3° per spigot-end socket connection)
- Unstressed installation conditions
- Low storage costs
- Non-earthed Hawle-Stop restraint joint
- Integrated, robust corrosion protection through Hawle epoxy powder coating
- Universal use with cast iron, steel**, PE***, PVC and AC**** pipes.

*Twist lock device: When installing BAIO® fittings (spigot end/socket connection), we generally recommend using the BAIO® twist lock device, order no.529-05, to prevent subsequent unlocking of the components.

**Only steel pipes with DCI pipe outside diameters (transitions for other steel pipes on request)

***When connecting PE pipes, support sleeves must be used.

****With cut-in socket fittings order no. 530-01 and 530-03 (no longitudinal force in AC pipes).

BAIO® double function socket

The BAIO® double function socket is suitable for positive locking connections with BAIO® spigot ends as well as for connecting cast iron, steel**, PE and PVC pipes. With the Hawle-Stop restraint, order no. 528-00, or BAIO®-SIT, order no. 527-00, these pipes can be locked into Hawle BAIO® push-fit sockets with longitudinal force. The seal must be selected according to the type of pipe. The BAIO® socket is supplied by default with a BAIO® lip seal

(BLD® seal). It must be used when connecting BAIO® spigot ends, cast iron pipes (steel pipes with DCI pipe outside diameter) and PE weld-in ends in BAIO® sockets. The GKS gasket must be used for PE and PVC pipes. Hawle support sleeves must always be used when connecting PE pipes, see in this regard also the overview on page 8.

Schematic diagram of a BAIO® spigot end/sleeve connection

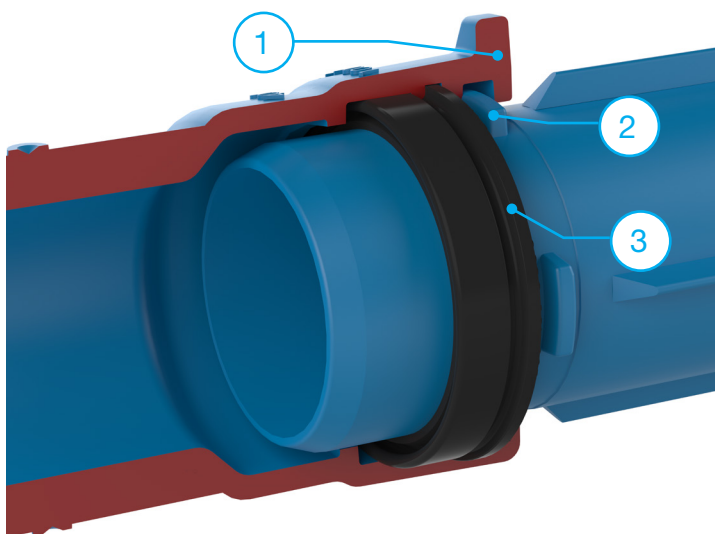

1. BAIO® double function socket with retaining lugs (for locking ring)
2. Locking cams
3. BAIO® lip seal BLD® (standard gasket)

Schematic diagram of a restraint joint-based connection in the BAIO® systems using a Hawle-Stop restraint, order no. 528-00 for PE pipes

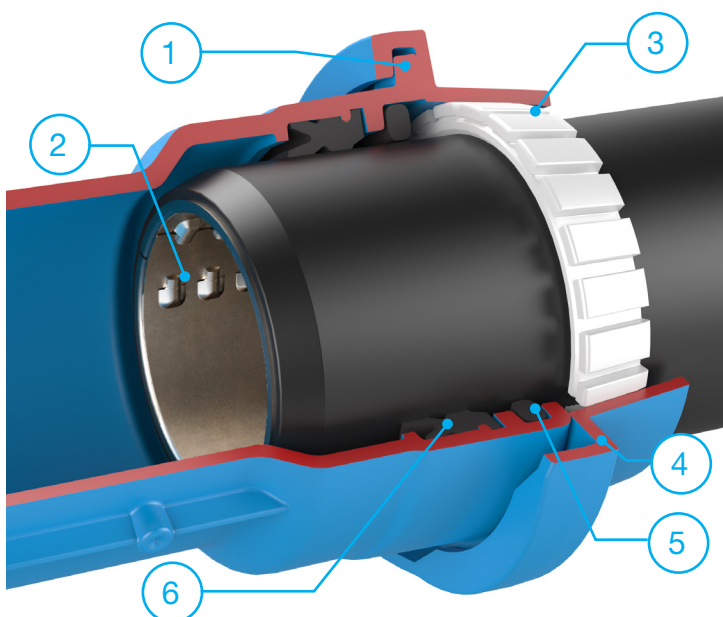

1. BAIO® double function socket with retaining lugs (for locking ring)
2. Hawle support sleeve
3. Grip ring (for PE pipes)
4. Locking ring
5. Socket dirt sealing
6. GKS gasket

System comparison: BAIO® system or flange system

2 parts: BAIO® system

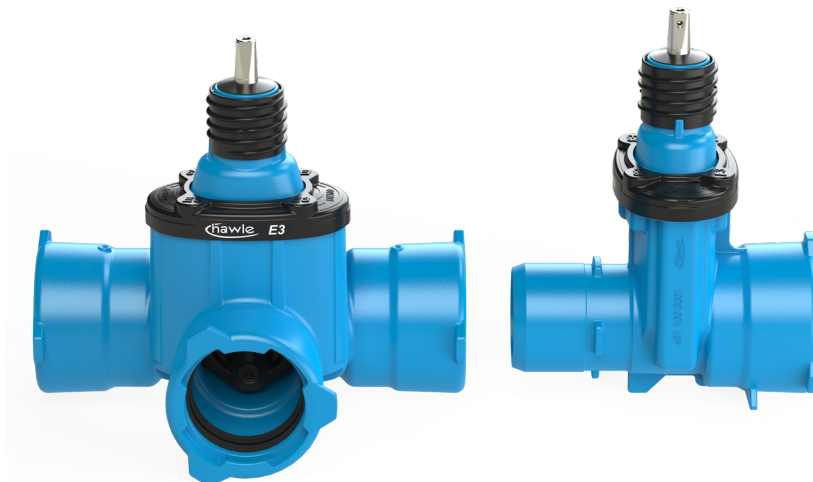

1 Combi-T gate valve "E3" (order no. 437-00)

1 Gate valve "E3" with spigot/socket (order no. 451-00)

171 parts: Flange system

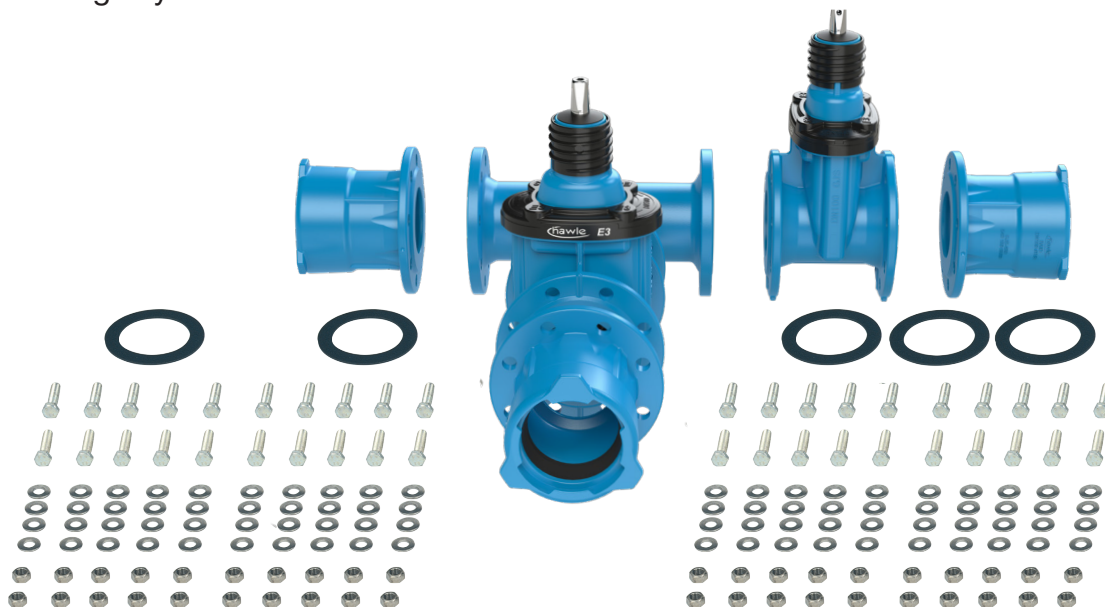

1 T-fitting (order no. 851-00)

40 bolts

2 gate valves "E3" (order no. 470-00)

40 nuts

3 EU-fittings (order no. 535-00)

80 washers

5 flat gaskets

System comparison: BAIO® system or flange system

5 parts: BAIO® system

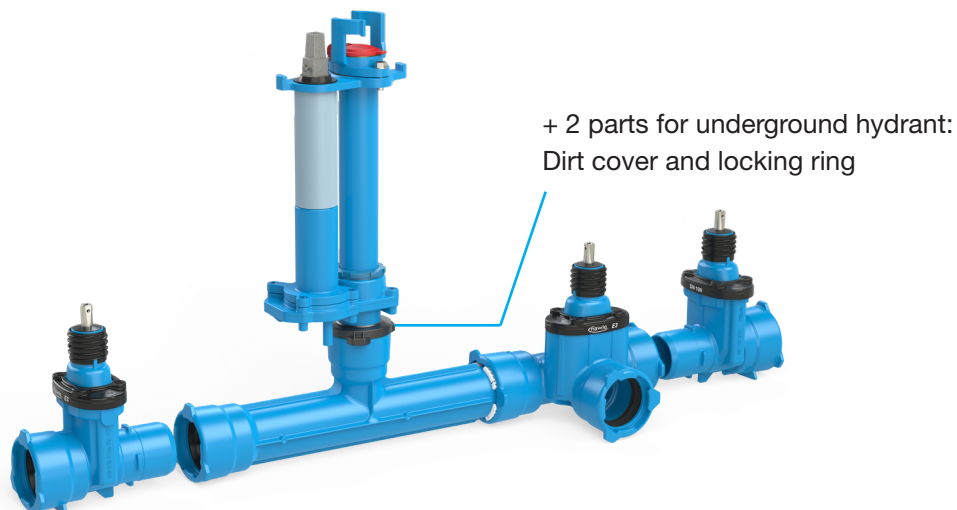

1 Combi-T gate valve "E3" (order no. 437-00)

1 freeflow underground hydrant (order no. 490-00)

1 B-fitting (order no. 537-00)

2 gate valves "E3" with spigot/socket (order no. 451-00)

307 parts: Flange system

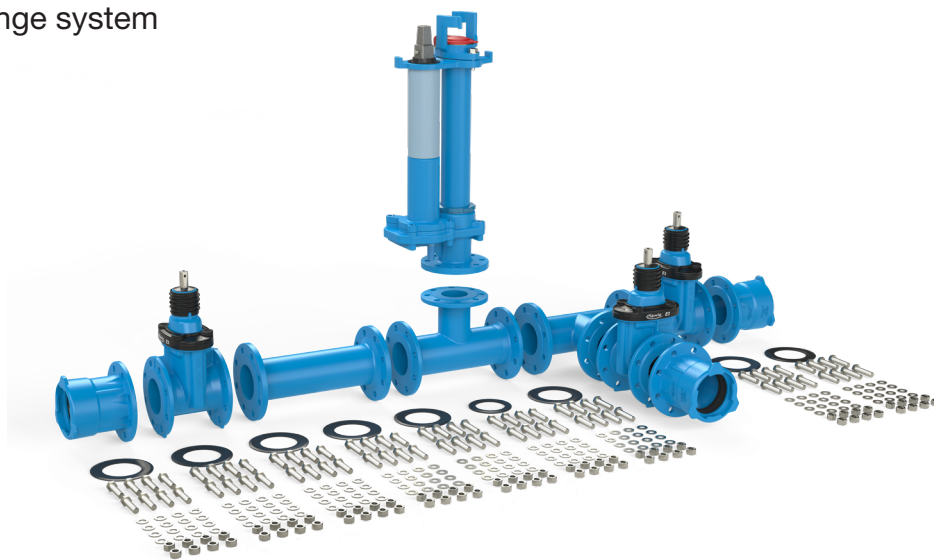

2 T-fittings (order no. 851-00)

9 flat gaskets

1 flanged pipe fitting (order no. 850-01)

72 bolts

3 flanged gate valves "E3" with oval body
(order no. 470-00)

72 nuts

3 EU-fittings (order no. 535-00)































144 washers

1 freeflow underground hydrant (order no. 490-00)

One push-fit socket - Various types of pipes



BAIO® socket

Gasket	Clamp	Locking ring	Pipe type
BLD® 	Segment ring 	Hawle-Stop 	DCI pipe / steel pipe with DCI pipe outside diameter DN 80 - DN 200 
BLD® 	Express ring 	BAIO®-Sit 	DCI pipe / steel pipe with DCI pipe outside diameter DN 250 - DN 300 
GKS 	Grip ring "Corundum" 	Hawle-Stop 	PVC pipe DN 80 - DN 200 
GKS 	Sliding Brass ring 	BAIO®-Sit 	PVC pipe DN 250 - DN 300 
GKS 	Grip ring 	Hawle-Stop 	Support sleeve PE/PEX pipe DN 80 - DN 200  
GKS 	Grip ring 	BAIO®-Sit 	Support sleeve PE/PEX pipe DN 250 - DN 300  
BBD 	Blutop-grip ring 	Hawle-Stop 	Blutop-pipe 

BAIO® system: Valves



437-00
Combi-T gate valve "E3"



437-00G
Combi-T gate valve "E3"
for gas



438-00
Combi-III gate valve "E3"



439-00
Combi-IV gate valve "E3"



450-00
Push-fit socket valve "E3"



450-00G
Push-fit socket valve "E3"
for gas



Maximum operating pressure

No.:	Description	Maximum operating pressure			Nominal diameter
437-00	Combi-T gate valve "E3"	16 bar	-	-	DN 80 - DN 200
437-00G	Combi-T gate valve "E3" for gas	-	-	16 bar	DN 80 - DN 150
438-00	Combi-III gate valve "E3"	16 bar	-	-	DN 100 - DN 200; *2 x ZAK 46; *2 x female thread (FT) 1½"; **BAIO® DN 80; **flange DN 100 (*Horizontal outlet, **Vertical outlet)
439-00	Combi-IV gate valve "E3"	16 bar	-	-	DN 100 - DN 200 Vertical outlet: BAIO® DN 80 or flange DN 100
450-00	Push-fit socket valve "E3"	16 bar	-	-	DN 80 - DN 300
450-00G	Push-fit socket valve "E3" for gas	-	-	16 bar	DN 80 - DN 300

For suitable valve accessories, please see our website.

BAIO® system: Gate valves, pipe fittings





No.:	Description	Maximum operating pressure			Nominal diameter
					
451-00	Gate valve "E3" with spigot/socket	16 bar	-	-	DN 80 - DN 300
451-00G	Gate valve "E3" with spigot/socket for gas	-	-	16 bar	DN 80 - DN 200
480-00	Sewage water knife gate valve with sockets	-	10 bar	-	DN 80 - DN 100
483-00	Sewage water knife gate valve spigot/socket	-	10 bar	-	DN 80 - DN 150
452-00	PE fusion end	10/16 bar	10/16 bar	5/10 bar	DN 80 - DN 300



For suitable valve accessories, please see our website.

BAIO[®] system: Pipe fittings







530-01
 Cut-in socket fitting with
 WAGA Multi/Joint[®]

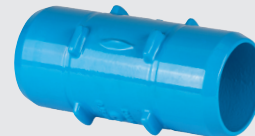





530-03
 Cut-in socket fitting with
 BAIO[®] spigot end
 and Synoflex socket







531-00
 S-fitting (spigot-end fitting)





532-00
 SM fitting (spigot end/socket fitting)

Maximum operating pressure

No.:	Description	Maximum operating pressure			Nominal diameter
					
530-01	Cut-in socket fitting with WAGA Multi/Joint [®]	16 bar	16 bar	-	DN 80 - DN 200
530-03	Cut-in socket fitting with BAIO [®] spigot end and Synoflex socket	16 bar	16 bar	-	DN 200 - DN 300
531-00	S-fitting (spigot-end fitting)	16 bar	16 bar	16 bar	DN 80 - DN 300
532-00	SM-fitting (spigot end/socket fitting)	16 bar	16 bar	1/16 bar	DN 80 - DN 200

BAIO[®] system: Pipe fittings



No.:	Description	Maximum operating pressure			Nominal diameter
532-01	SM-fitting with ZAK [®] outlets	16 bar	16 bar	-	DN 80 - 300, ZAK 46 (only DN 80 - DN 200), ZAK 69 (only DN 250, DN 300)
532-02	SM-fitting with PE-end	16 bar	16 bar	1/5 bar	DN 80
532-03	SM-fitting (Synoflex transition piece)	16 bar	16 bar	-	DN 80 - DN 300
533-00	SM-fitting with steel end	16 bar	-	1/5 bar	DN 80
535-00	F-fitting (flanged spigot fitting)	10/16 bar	10/16 bar	10/16 bar	DN 80 - DN 300
536-00	Concentric taper (R-reduced socket / RU-reduced spigot end)	16 bar	16 bar	1/16 bar	DN 80 - DN 300

BAIO® system: Pipe fittings



No.:	Description	Maximum operating pressure			Nominal diameter
537-00	B-fitting (BAIO® socket)	16 bar	16 bar	-	DN 80 - DN 200; upper outlet: DN 80
537-01	A-fitting (flange connection)	16 bar	16 bar	-	DN 80 - DN 200; upper outlet: DN 80
538-00	Double tee cross	16 bar	16 bar	1/16 bar	DN 80 - DN 200
538-01	Double tee cross with vertical outlet Double-flanged taper / EU-fitting	16 bar	-	-	DN 80 - DN 300 (double tee cross) DN 80 (double-flanged and EU)
359-00	Double-strap pipe drilling saddle with BAIO® socket	16 bar	16 bar	5 bar	DN 80

BAIO[®] system: Pipe fittings



No.:	Description	Maximum operating pressure			Nominal diameter
540-00	EU-fitting (flanged socket)	10/16 bar	10/16 bar	1/10/16 bar	DN 80 - DN 300
541-00	U-fitting (collar) Optionally with female thread or ZAK [®] outlet	16 bar	16 bar	1/16 bar*	without/with outlet ZAK 46/ 1 x 2", 2 x 2": DN 80 - 200 Outlet ZAK 69: DN 100 - 300
542-00	All socket tee	16 bar	16 bar	1/16 bar	DN 80 - DN 300
543-00	Double socket bend 90°	16 bar	16 bar	1/16 bar	DN 80 - DN 200
543-01	MSQ-fitting 90°	16 bar	16 bar	1/16 bar	DN 80
544-00	Double socket bend 45°	16 bar	16 bar	1/16 bar	DN 80 - DN 300

*only without outlet

BAIO[®] system: Pipe fittings



544-01
Spigot socket bend 45°



545-00
Double socket bend 30°



546-00
Double socket bend 22°



546-01
Spigot socket bend 22°



547-00
Double socket bend 11°



548-00
Duckfoot bend

Maximum operating pressure

No.:	Description	Maximum operating pressure			Nominal diameter
544-01	Spigot socket bend 45°	16 bar	16 bar	1/16 bar	DN 80 - DN 300
545-00	Double socket bend 30°	16 bar	16 bar	1/16 bar	DN 80 - DN 300
546-00	Double socket bend 22°	16 bar	16 bar	1/16 bar	DN 80 - DN 300
546-01	Spigot socket bend 22°	16 bar	16 bar	1/16 bar	DN 80 - DN 200
547-00	Double socket bend 11°	16 bar	16 bar	1/16 bar	DN 80 - DN 300
548-00	Duckfoot bend	16 bar	16 bar	-	DN 80 - DN 100 Optional outlets: 2 x 1½" FT; 1 x ZAK 46; 2 x ZAK 46; 3 x ZAK 46

BAIO[®] system: Pipe fittings



549-00
EN-fitting



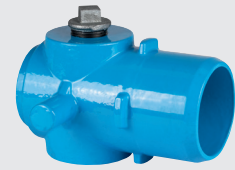

806-00
Socket end cap



807-00
Spigot end cap

Maximum operating pressure

No.:	Description	Maximum operating pressure			Nominal diameter
					
549-00	EN-fitting	16 bar	16 bar	-	DN 80 - DN 150 Optional outlets: 2 x 1½" FT; 1x ZAK 46; 2x ZAK 46; 3 x ZAK 46
806-00	Socket end cap	16 bar	16 bar	1/5 bar	DN 80 - DN 200 FT 1"- 1½"
807-00	Spigot end cap	16 bar	16 bar	5 bar	DN 80 - DN 300 FT 1"-2"

BAIO® system: Restraint joints / Accessories

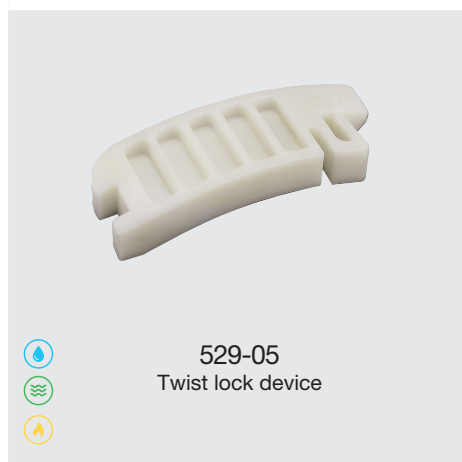
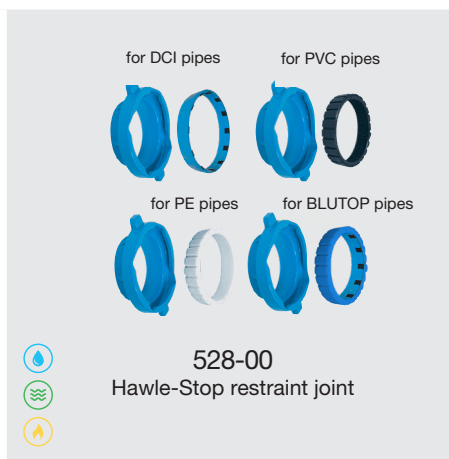
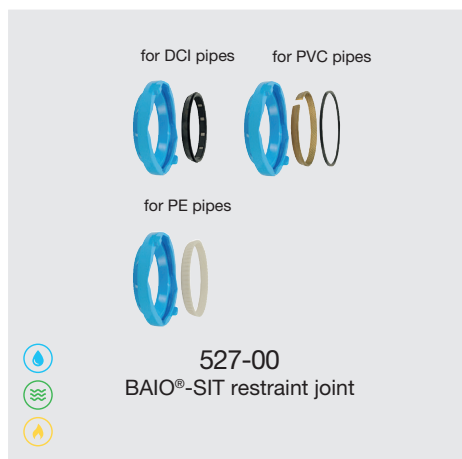

Maximum operating pressure

No.:	Description	Maximum operating pressure			Nominal diameter
		Water	Sewer	Fire	
527-00	BAIO®-SIT restraint joint	16 bar	16 bar	1/16 bar	DN 250 - DN 300
528-00	Hawle-Stop restraint joint	16 bar	16 bar	1/16 bar	DN 80 - DN 200
490-05	Dirt cover and locking ring for BAIO® spigot ends	16 bar	16 bar	-	DN 80
529-05	Twist lock device	16 bar	16 bar	16 bar	DN 80 - DN 300

BAIO® system: Gaskets



529-00
BAIO® lip seal
(BLD®)



529-01
GKS gasket



529-01G
GKS gasket for gas



529-02
BAIO® BLUTOP gasket



529-03G
DCI pipe gasket for gas



529-04
Dirt gasket for sockets



Maximum operating pressure

No.:	Description	Maximum operating pressure			Nominal diameter
529-00	BAIO® lip seal (BLD®)	16 bar	16 bar	-	DN 80 - DN 300
529-01	GKS gasket	16 bar	16 bar	-	DN 80 - DN 300
529-01G	GKS gasket for gas	-	-	1 bar (PVC only)	DN 80 - DN 300
529-02	BAIO® BLUTOP gasket	16 bar	16 bar	-	DN 80 - DN 150
529-03G	DCI pipe gasket for gas	-	-	16 bar	DN 80 - DN 300
529-04	Dirt gasket for sockets	-	-	-	DN 80 - DN 200

Hydrants with BAIO® spigot end



Maximum operating pressure

No.:	Description	Maximum operating pressure			Nominal diameter
					
490-00	Freeflow underground hydrant	16 bar	-	-	DN 80 pipe cover depth: 0.77 m; 1.00 m; 1.25 m; 1.50 m; 1.80 m; 2.20 m; 2.40 m*
490-01	Freeflow underground hydrant with duckfoot bend	16 bar	-	-	DN 80 pipe cover depth: 1.00 m; 1.25 m; 1.50 m*
490-02	Freeflow underground hydrant set	16 bar	-	-	DN 80 pipe cover depth: 1.00 m, 1.25 m, 1.50 m
492-00	Tele-Hydrant® 2 B outlets or 2 C outlets	16 bar	-	-	DN 80 pipe cover depth: 1.00 m; 1.25 m; 1.50 m*
494-00	Freeflow underground hydrant "height adjustable"	16 bar	-	-	DN 80 pipe cover depth: 1.00 - 1.30 m; 1.25 - 1.55 m; 1.30 - 1.65 m; 1.50 - 2.05 m; 2.00 - 2.55 m*
519-00	Above ground hydrant with predetermined breaking point	16 bar	-	-	DN 80 pipe cover depth: 1.25 m; 1.50 m*

* Special lengths available on request

For suitable hydrant accessories, please see our website.

Air valve sets with BAIO[®] spigot end



985-00
Air valve set
for sewage





992-00
Air valve set
HaVent[®] PN16



993-00
Air valve set
HaVent[®] for potable water

Maximum operating pressure

No.:	Description	Maximum operating pressure			Nominal diameter
					
985-00	Air valve set for sewage	-	16 bar	-	DN 80 pipe cover depth: 1.25 m; 1.50 m
992-00	Air valve set HaVent [®]	16 bar	-	-	DN 80 pipe cover depth: 1.00 m; 1.25 m; 1.50 m; 1.75 m
993-00	Air valve set HaVent [®] for potable water	16 bar	-	-	DN 80 pipe cover depth: 1.00 m; 1.25 m; 1.50 m; 1.75 m

For suitable accessories for our air valve sets, please see our website.

Technical features: ZAK® system

ZAK® system threadless connection

Our ZAK® system is an optimal alternative to threaded connections.

ZAK is an acronym for:

Zugsicher (with restraint joint for high tensile strength)

Arretiert (locked to secure joint)

Korrosionsgeschützt (corrosion-resistant).

Locking and sealing

During installation, the ZAK® spigot end is inserted in the ZAK® socket, locked by turning it 90° clockwise and fully retracted. To lock the ZAK® spigot end in the ZAK® socket, the connection must also be secured against unintentional disconnection by means of an anti-twist device.

The bayonet connection, consisting of a corrosion-resistant socket with an internal bayonet locking mechanism and equally corrosion-resisting spigot end with locking lugs and a double O-ring sealing, guarantees that the connection is reliably sealed.



Technical features

- Medium: Potable water, sewage water, gas
- Nominal diameters:
 - ZAK 34 - corresponds to a dimension of 1"
 - ZAK 46 - corresponds to a dimension of 1½"
 - ZAK 69 - corresponds to a dimension of 2"(ZAK 69 is not suitable for gas)
- Max. operating pressure: for potable water 16 bar; for sewage 10 or 16 bar; for gas, depending on product
- Simple, quick installation
- Threadless connection system
- Reduced tension due to flexible connection
- Safe double O-ring sealing of the connection
- Long service life due to integral corrosion protection
- No tools required for installation

Pipe drilling in the ZAK® system

The Hawlomat pipe drilling device by Hawle serves to drill holes of 1" to 2" into cast iron, steel, PVC, PE and AC water pipes and sewage pressure pipelines. The ZAK 69 system has been developed specifically for the sewage sector. In conjunction with a pipe drilling fitting, it is also possible to drill a hole in operating conditions with a max. operating pressure of 16 bar.



Application example from potable water range
Tapping an existing PE distribution pipe through HAKU Hawlinger ZAK 46

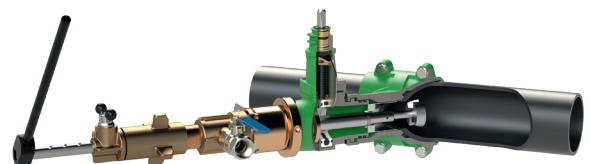

Application example from sewage range
Tapping a waste pipeline through ZAK 69 sewage water service valve using HAKU pipe drilling saddle 45° (order no. 524-00) and ZAK 69 pipe drilling set for 45° drilling

Further information on our Hawlomat or our rental pipe drilling devices is available on our website at www.hawle.de/en/.

ZAK® system: Pipe drilling fittings



226-00

Hawlinger with upper vertical ZAK® socket and lower tapered male thread or lower ZAK® spigot end



226-00G

Hawlinger for gas with upper vertical ZAK® socket and lower tapered male thread or lower ZAK® spigot end



227-00

Hawlinger with upper horizontal ZAK® socket in pipe direction and lower tapered male thread or lower ZAK® spigot end



227-00G

Hawlinger for gas with upper horizontal ZAK® socket in pipe direction and lower tapered male thread or lower ZAK® spigot end



228-00

Hawlinger with horizontal ZAK® socket 90° to pipe direction and lower tapered male thread



with PE-X fusion end

229-03

Hawlinger with upper vertical ZAK® socket and lower PE-X fusion end

Maximum operating pressure

No.:	Description	Maximum operating pressure			Nominal diameter
226-00	Hawlinger with upper vertical ZAK® socket and lower tapered male thread or lower ZAK® spigot end	16 bar	-	-	Lower outlet: male thread (MT) 1¼", 2" tapered or ZAK 46 upper outlet: ZAK 34, ZAK 46
226-00G	Hawlinger for gas with upper vertical ZAK® socket and lower tapered male thread or lower ZAK® spigot end	-	-	5 bar	Lower outlet: MT 2", tapered or ZAK 46 upper outlet: ZAK 46
227-00	Hawlinger with upper horizontal ZAK® socket in pipe direction and lower tapered male thread or lower ZAK® spigot end	16 bar	-	-	Lower outlet: MT 1¼" - 2", tapered or ZAK 46, upper outlet: ZAK 34, ZAK 46
227-00G	Hawlinger for gas with upper horizontal ZAK® socket in pipe direction and lower tapered male thread or lower ZAK® spigot end	-	-	5 bar	Lower outlet: MT 1½" - 2", tapered or ZAK 46, upper outlet: ZAK 46
228-00	Hawlinger with horizontal ZAK® socket 90° to pipe direction and lower tapered male thread	16 bar	-	-	Lower outlet: MT 1¼" - 2", tapered upper outlet: ZAK 34, ZAK 46
229-03	Hawlinger with upper vertical ZAK® socket and lower PE-X fusion end	16 bar	-	-	Lower outlet: d 63 mm upper outlet: ZAK 34, ZAK 46

ZAK[®] system: Pipe drilling fittings



with PE-X fusion end



229-03G

Hawlinger for gas with upper vertical ZAK[®] socket and with lower PE fusion end



with PE-X fusion end



229-04

Hawlinger with upper horizontal ZAK[®] socket in pipe direction and with lower PE fusion end



with PE-X fusion end



229-04G

Hawlinger for gas with upper horizontal ZAK[®] socket in pipe direction and with lower PE fusion end



with PE-X fusion end



229-05

Hawlinger with upper horizontal ZAK[®] socket 90° to pipe direction and lower PE fusion end



with PE-X fusion end



229-05G

Hawlinger for gas with upper horizontal ZAK[®] socket 90° to pipe direction and lower PE fusion end



236-00

HAKU Hawlinger with vertical ZAK[®] socket

Maximum operating pressure



No.:

Description

Nominal diameter

No.:	Description				Nominal diameter
229-03G	Hawlinger for gas with upper vertical ZAK [®] socket and lower PE-X fusion end	-	-	5 bar	Lower outlet: d 63 mm upper outlet: ZAK 46
229-04	Hawlinger with upper horizontal ZAK [®] socket in pipe direction and with lower PE-fusion end	16 bar	-	-	Lower outlet: d 63 mm upper outlet: ZAK 34, ZAK 46
229-04G	Hawlinger for gas with upper horizontal ZAK [®] socket in pipe direction and with lower PE fusion end	-	-	5 bar	Lower outlet: d 63 mm upper outlet: ZAK 46
229-05	Hawlinger with upper horizontal ZAK [®] socket 90° to pipe direction and lower PE fusion end	16 bar	-	-	Lower outlet: d 63 mm upper outlet: ZAK 34, ZAK 46
229-05G	Hawlinger for gas with upper horizontal ZAK [®] socket 90° to pipe direction and lower PE fusion end	-	-	5 bar	Lower outlet: d 63 mm upper outlet: ZAK 46
236-00	HAKU Hawlinger with vertical ZAK [®] socket	16 bar	-	-	Outlet ZAK 34, ZAK 46: pipe: d 63, 75, 90, 110, 125, 140, 160, 180, 225, 250, 280, 315 mm outlet ZAK 69: pipe: d 110, 125, 140, 160, 180, 225 mm

For suitable accessories for pipe drilling fittings/service valves, please see our website.

www.hawle.de/en/

ZAK[®] system: Pipe drilling fittings



236-00G
HAKU Hawlinger
with vertical ZAK[®] socket
for gas



237-00
HAKU Hawlinger
with horizontal ZAK[®] socket
in pipe direction

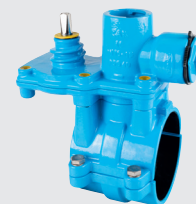

237-00G
HAKU Hawlinger
with horizontal ZAK[®] socket
in pipe direction for gas



237-02
HAKU Hawlinger rotatable,
with horizontal ZAK[®] socket
in pipe direction



238-00
HAKU Hawlinger
with horizontal ZAK[®] socket
90° to pipe direction



238-00G
HAKU Hawlinger for gas
with horizontal ZAK[®] socket
90° to pipe direction

Maximum operating pressure

No.:	Description	Maximum operating pressure			Nominal diameter
236-00G	HAKU Hawlinger for gas with vertical ZAK [®] socket	-	-	1 bar (PVC only)	Outlet: ZAK 34, ZAK 46 pipe: d 63, 90, 110, 125, 140, 160, 180, 225 mm
237-00	HAKU Hawlinger with horizontal ZAK [®] socket in pipe direction	16 bar	-	-	Outlet: ZAK 34, ZAK 46 pipe: d 63, 75, 90, 110, 125, 140, 160, 180, 225, 250, 280, 315 mm
237-00G	HAKU Hawlinger for gas with horizontal ZAK [®] socket in pipe direction	-	-	1 bar (PVC only)	Outlet: ZAK 34, ZAK 46 pipe: d 63, 90, 110, 125, 140, 160, 180, 225, 280 mm
237-02	HAKU Hawlinger rotatable, with horizontal ZAK [®] socket in pipe direction	16 bar	-	-	Outlet: ZAK 46 pipe: d 90, 110, 125, 140, 160, 180, 225 mm
238-00	HAKU Hawlinger with horizontal ZAK [®] socket 90° to pipe direction	16 bar	-	-	Outlet: ZAK 34, ZAK 46 pipe: d 63, 75, 90, 110, 125, 140, 160, 180, 225, 250, 280, 315 mm
238-00G	HAKU Hawlinger for gas with horizontal ZAK [®] socket 90° to pipe direction	-	-	1 bar (PVC only)	Outlet: ZAK 34, ZAK 46 pipe: d 63, 90, 110, 125, 140, 160, 180, 225 mm

For suitable accessories for pipe drilling fittings/service valves, please see our website.

ZAK[®] system: Pipe drilling fittings



 **239-00**
Hawlinger with upper vertical ZAK[®] socket and lower electrofusion saddle



 **239-00G**
Hawlinger for gas with upper vertical ZAK[®] socket and lower electrofusion saddle



 **239-01**
Hawlinger with upper horizontal ZAK[®] socket in pipe direction and with lower electrofusion saddle



 **239-01G**
Hawlinger for gas with upper horizontal ZAK[®] socket in pipe direction and with lower electrofusion saddle





 **239-02**
Hawlinger with upper horizontal ZAK[®] socket 90° to pipe direction and lower electrofusion saddle





 **239-02G**
Hawlinger for gas with upper horizontal ZAK[®] socket 90° to pipe direction and lower electrofusion saddle

Maximum operating pressure

No.:	Description	Maximum operating pressure			Nominal diameter
					
239-00	Hawlinger with upper vertical ZAK [®] socket and lower electrofusion saddle	16 bar	-	-	Outlet: ZAK 34, ZAK 46 pipe: d 63, 90, 110, 125, 160, 180, 225 mm
239-00G	Hawlinger for gas with upper vertical ZAK [®] socket and lower electrofusion saddle	-	-	10 bar	Outlet: ZAK 46 pipe: d 90, 110, 125, 160, 180, 225 mm
239-01	Hawlinger with upper horizontal ZAK [®] socket in pipe direction and with lower electrofusion saddle	16 bar	-	-	Outlet: ZAK 34, ZAK 46 pipe: d 63, 90, 110, 125, 160, 180, 225 mm
239-01G	Hawlinger for gas with upper horizontal ZAK [®] socket in pipe direction and with lower electrofusion saddle	-	-	10 bar	Outlet: ZAK 34, ZAK 46 pipe: d 63, 90, 110, 125, 160, 180, 225 mm
239-02	Hawlinger with upper horizontal ZAK [®] socket 90° to pipe direction and lower electrofusion saddle	16 bar	-	-	Outlet: ZAK 34, ZAK 46 pipe: d 63, 90, 110, 125, 160, 180, 225 mm
239-02G	Hawlinger for gas with upper horizontal ZAK [®] socket 90° to pipe direction and lower electrofusion saddle	-	-	10 bar	Outlet: ZAK 34, ZAK 46 pipe: d 90, 110, 125, 160, 180, 225 mm

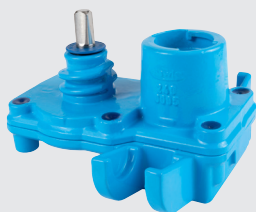
ZAK[®] system: Pipe drilling fittings



 **243-00**
Universal Hawlinger
with vertical ZAK[®] socket



 **243-00G**
Universal Hawlinger
with vertical ZAK[®] socket
for gas



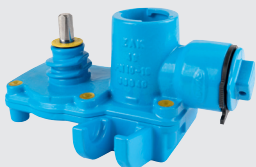

 **244-00**
Universal Hawlinger
with horizontal ZAK[®] socket
in pipe direction



 **244-00G**
Universal Hawlinger for gas
with horizontal ZAK[®] socket
in pipe direction

Maximum operating pressure

No.:	Description	Maximum operating pressure			Nominal diameter
					
243-00	Universal Hawlinger with vertical ZAK [®] socket	16 bar	-	-	Outlet: ZAK 34, ZAK 46 pipe: DN 65 - 500 outlet: ZAK 69 pipe: DN 100 - 500
243-00G	Universal Hawlinger for gas with vertical ZAK [®] socket	-	-	5 bar	Outlet: ZAK 34, ZAK 46 pipe: DN 65 - 500
244-00	Universal Hawlinger with horizontal ZAK [®] socket in pipe direction	16 bar	-	-	Outlet: ZAK 34, ZAK 46 pipe: DN 65 - 500
244-00G	Universal Hawlinger for gas with horizontal ZAK [®] socket in pipe direction	-	-	5 bar	Outlet: ZAK 34, ZAK 46 pipe: DN 65 - 500

For suitable accessories for pipe drilling fittings/service valves, please see our website.

ZAK[®] system: Pipe drilling fittings

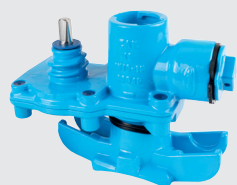

 **244-01**
Universal-Hawlinger, rotatable,
horizontal ZAK[®] socket
in pipe direction

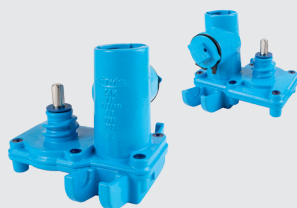

 **245-00**
Universal Hawlinger
with horizontal ZAK[®] socket
90° to pipe direction



 **245-00G**
Universal Hawlinger for gas
with horizontal ZAK[®] socket
90° to pipe direction

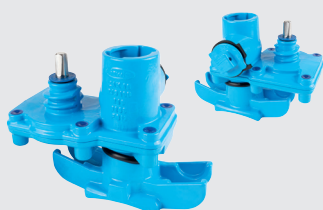

 **245-01**
Universal-Hawlinger, rotatable,
with horizontal ZAK[®] socket
90° to pipe direction



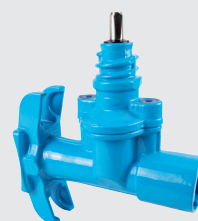

 **245-02**
Universal Hawlinger for later
drilling with vertical ZAK[®] outlet and
horizontal ZAK[®] outlet 90° to pipe direction



 **270-01**
Valve saddle with
ZAK[®] outlet

Maximum operating pressure

No.:	Description	Maximum operating pressure			Nominal diameter
					
244-01	Universal-Hawlinger, rotatable, with horizontal ZAK [®] socket in pipe direction	16 bar	-	-	Outlet: ZAK 46 pipe: DN 65 - 500
245-00	Universal Hawlinger with horizontal ZAK [®] socket 90° to pipe direction	16 bar	-	-	Outlet: ZAK 34, ZAK 46 pipe: DN 65 - 500
245-00G	Universal Hawlinger with horizontal ZAK [®] socket 90° to pipe direction	-	-	5 bar	Outlet: ZAK 34, ZAK 46 pipe: DN 65 - 500
245-01	Universal-Hawlinger, rotatable, with horizontal ZAK [®] socket 90° to pipe direction	16 bar	-	-	Outlet: ZAK 46 pipe: DN 65 - 500
245-02	Universal Hawlinger for later drilling with vertical and horizontal ZAK [®] outlet 90° to pipe direction	16 bar	-	-	Outlet: ZAK 46 pipe: DN 65 - 500
270-01	Valve saddle with ZAK [®] outlet	16 bar	-	-	Outlet: ZAK 46 pipe: DN 65 - 500

For suitable accessories for pipe drilling fittings/service valves, please see our website.

ZAK® system: Pipe drilling fittings

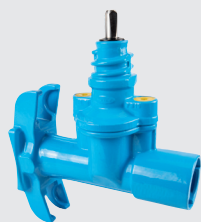

270-01G
Valve saddle with ZAK® outlet for gas



313-00
HAKU milling saddle with horizontal ZAK® socket



313-01
HAKU milling saddle (with punch bore) for PE pipes with horizontal ZAK® socket



352-00
Universal pipe drilling saddle with ZAK® socket



371-00
Universal pipe saddle with integrated shut-off function



371-00G
Universal pipe saddle with integrated shut-off function for gas

Maximum operating pressure

No.:	Description	Maximum operating pressure			Nominal diameter
270-01G	Valve saddle with ZAK® outlet for gas	-	-	5 bar	Outlet: ZAK 46 pipe: DN 65 - 500
313-00	HAKU milling saddle with horizontal ZAK® socket	16 bar	-	-	Outlet: ZAK 46 pipe: PE, SDR11: d 63 - 225mm PE, SDR17: d 63 - 315mm PVC, PN 10: d 63 - 280 mm PVC, PN 16: d 63 - 160 mm
313-01	HAKU milling saddle (with punch bore) for PE pipes with horizontal ZAK® socket	16 bar	-	-	Outlet: ZAK 46 pipe: PE, SDR11: d 63 - 225 mm PE, SDR17: d 63 - 315 mm
352-00	Universal pipe drilling saddle with ZAK® socket	16 bar	16 bar	5 bar	Outlet: ZAK 46, ZAK 69* pipe: DN 65 - 500
371-00	Universal pipe drilling saddle with ZAK® socket and integrated shut-off function	16 bar	16 bar	-	Outlet: ZAK 46 pipe: DN 65 - 500
371-00G	Universal pipe saddle with ZAK® socket and integrated shut-off function for gas	-	-	5 bar	Outlet: ZAK 46 pipe: DN 65 - 500

* ZAK 69 not suitable for gas

For suitable accessories for pipe drilling fittings/service valves, please see our website.

www.hawle.de/en/

ZAK® system: Pipe drilling fittings



372-01
Shut-off adaptor with ZAK® outlet



522-00
HAKU pipe saddle with ZAK® outlet and auxiliary shut-off device



524-00
HAKU pipe saddle with 45° ZAK® outlet (ZAK 69)



525-01
HAKU pipe saddle with ZAK® outlet



525-01G
HAKU pipe saddle with ZAK® outlet for gas



526-00
HA-WELD® electrofusion saddle with ZAK® outlet

Maximum operating pressure

No.:	Description	Maximum operating pressure			Nominal diameter
372-01	Shut-off adaptor with ZAK® outlet	16 bar	16 bar	-	ZAK 46, ZAK 69
522-00	HAKU pipe saddle with ZAK® outlet and auxiliary shut-off device	16 bar	-	-	Outlet: ZAK 34, ZAK 46 pipe: d 90, 110, 140, 160, 225 mm
524-00	HAKU pipe saddle with 45° ZAK® outlet (ZAK 69)	16 bar	16 bar	-	Outlet: ZAK 69 pipe: d 63, 75, 90, 110, 140, 160, 225 mm
525-01	HAKU pipe saddle with ZAK® outlet	16 bar	16 bar	-	Outlet: ZAK 46, ZAK 69 pipe: d 63, 75, 90, 110, 125, 140, 160, 180, 225 mm
525-01G	HAKU pipe saddle with ZAK® outlet for gas	-	-	1 bar (PVC only)	Outlet: ZAK 46 pipe: d 63, 75, 90, 110, 125, 140, 160, 180, 225 mm
526-00	HA-WELD® electrofusion saddle with ZAK® outlet	16 bar	-	10 bar	Outlet: ZAK 46 pipe: d 90, d 110, d 125, d 160, d 225 mm

For suitable accessories for pipe drilling fittings/service valves, please see our website.

ZAK[®] system: Service valve



253-00
Service valve
with ZAK[®] spigot end
and ZAK[®] socket



253-00G
Service valve for gas
with ZAK[®] spigot end
and ZAK[®] socket



253-01
Service valve
with ZAK[®] sockets



255-00
Service valve
with ZAK[®] socket and flange

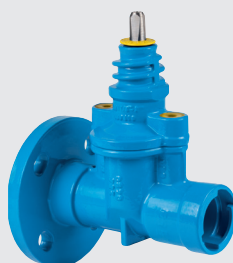

255-00G
Service valve for gas
with ZAK[®] socket
and flange



281-00
Service valve
with ZAK[®] spigot end
and push-fit socket

Maximum operating pressure

No.:	Description	Maximum operating pressure			Nominal diameter
253-00	Service valve with ZAK [®] spigot end and ZAK [®] socket	16 bar	-	-	ZAK 46, ZAK 69
253-00G	Service valve for gas with ZAK [®] spigot end and ZAK [®] socket	-	-	5 bar	ZAK 46
253-01	Service valve with ZAK [®] sockets	16 bar	-	-	ZAK 46, ZAK 69
255-00	Service valve with ZAK [®] socket and flange	16 bar	-	-	ZAK 46 flange DN 40, DN 50
255-00G	Service valve for gas with ZAK [®] socket and flange	-	-	5 bar	ZAK 46 flange DN 40, DN 50
281-00	Service valve with ZAK [®] spigot end and push-fit socket	16 bar	-	-	ZAK 34, ZAK 46 d 25, 32, 40, 50, 63 mm

For suitable accessories for pipe drilling fittings/service valves, please see our website.

ZAK® system: Service valves / Fittings



 **312-00**
Angled service valve with
ZAK® spigot end and push-fit socket



 **312-01**
Angled service valve,
swivel-type, with ZAK® spigot end
and ZAK® socket





 **312-02**
ZAK angled service valve
with ZAK® spigot end
and ZAK® socket





 **483-01**
Service valve for sewage (ZAK 69) with
ZAK® spigot end
and ZAK® socket



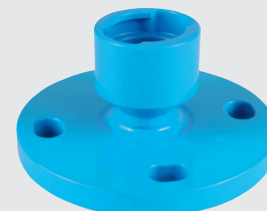

   **536-01**
Transition fitting BAIO®
spigot end / ZAK® socket



   **551-00**
Adaptor
with flange and ZAK® socket

Maximum operating pressure

No.:	Description	Maximum operating pressure			Nominal diameter
					
312-00	Angled service valve with ZAK® spigot end and push-fit socket	16 bar	-	-	ZAK 34, ZAK 46 d 25, 32, 40, 50 mm
312-01	Angled service valve, swivel type, with ZAK® spigot end and ZAK® socket	16 bar	-	-	ZAK 46
312-02	ZAK angled service valve with ZAK® spigot end and ZAK® socket	16 bar	-	-	ZAK 46
483-01	Service valve for sewage (ZAK 69) with ZAK® spigot end and ZAK® socket	-	10 bar	-	ZAK 69
536-01	Transition fitting BAIO® spigot end / ZAK® socket	16 bar	16 bar	10 bar	ZAK 46, ZAK 69* DN 80
551-00	Adaptor with flange and ZAK® socket	16 bar	16 bar	10 bar	ZAK 46, ZAK 69* DN 40 - 80



* ZAK 69 not suitable for gas

For suitable accessories for pipe drilling fittings/service valves, please see our website.

www.hawle.de/en/

ZAK® system: Fittings





No.:	Description	Maximum operating pressure			Nominal diameter
					
616-00	Push-fit socket with ZAK® spigot end	16 bar	16 bar	-	ZAK 34, ZAK 46, ZAK 69 pipe: d 25, 32, 40, 50, 63, 75 mm
616-01	Push-fit socket with detachable taper ring and ZAK® spigot end "Type N"	16 bar	16 bar	-	ZAK 46 Pipe: d 32, 40, 50 mm
616-02	Rehabilitation fitting with detachable taper ring and ZAK® spigot end "Type N"	16 bar	16 bar	-	ZAK 34, ZAK 46, ZAK 69 Pipe: d 32, 40, 50, 63 mm

ZAK[®] system: Fittings





Maximum operating pressure

No.:	Description	Maximum operating pressure			Nominal diameter
					
618-00	ZAK [®] PE-end	16 bar	16 bar	-	ZAK 34, ZAK 46, ZAK 69 Pipe: d 32, 40, 50, 63 mm
618-00G	ZAK [®] PE-end for gas	-	-	10 bar	ZAK 34, ZAK 46 Pipe: d 32, d 40, d 50, d 63
618-01	Transition fitting with ZAK [®] socket and male thread (tapered or cylindrical)	16 bar	16 bar	10 bar	ZAK 34, ZAK 46, ZAK 69* MT tapered/cylindrical 1", 1¼", 1½", 2", 3"
618-02	Adaptor ZAK [®] socket / screw socket	16 bar	16 bar	-	ZAK 34, ZAK 46 DN 40 - DN 50
618-03	ZAK [®] end cap	16 bar	16 bar	5 bar	ZAK 46, ZAK 69*
618-04	Transition fitting - ZAK [®] (ZAK 46) on male thread	16 bar	-	-	ZAK 46 MT: 1", 1¼"



* ZAK 69 not suitable for gas

ZAK[®] system: Fittings







618-05
 Transition fitting with ZAK[®]
 spigot end and
 female thread







626-00
 Transition fitting with
 ZAK[®] socket





630-00
 Connector (S-fitting, short)
 with two ZAK[®] spigot ends







630-01
 Connector (S-fitting) with
 two ZAK[®] spigot ends







630-01G
 Connector (S-fitting) with
 two ZAK[®] spigot ends
 for gas





630-02
 Connector (S-fitting, swivel type)
 with
 two ZAK[®] spigot ends

Maximum operating pressure

No.:	Description	Maximum operating pressure			Nominal diameter
					
618-05	Transition fitting with ZAK [®] spigot end and female thread	16 bar	16 bar	-	ZAK 46 FT: 1¼", 1½"
626-00	Transition fitting with ZAK [®] socket	16 bar	16 bar	-	ZAK 69 d 75
630-00	Connector (S-fitting, short) two ZAK [®] spigot ends	16 bar	16 bar	-	ZAK 46, ZAK 69
630-01	Connector (S-fitting) with two ZAK [®] spigot ends	16 bar	16 bar	-	ZAK 46
630-01G	Connector (S-fitting) with two ZAK [®] spigot end for gas	-	-	10 bar	ZAK 46
630-02	Connector (S-fitting, rotatable) with two ZAK [®] spigot ends	16 bar	16 bar	-	ZAK 46

ZAK[®] system: Fittings



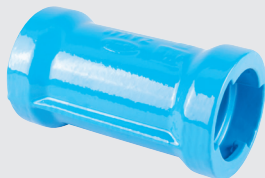

 **630-02G**
Connector (S-fitting, rotatable) with two ZAK[®] spigot ends for gas





   **630-03**
Transition piece with two ZAK[®] sockets

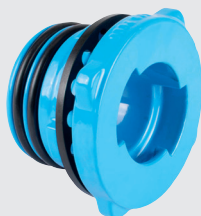

  **630-04**
Rotatable junction with ZAK[®] spigot end / socket



  **630-05**
Reduction fitting with ZAK[®] spigot end and ZAK[®] socket, reduced

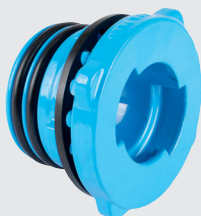



 **630-05G**
Reduction fitting with ZAK[®] spigot end and ZAK[®] socket, reduced for gas



 **630-08**
Transition from ZAK[®] spigot end and ZAK[®] socket

Maximum operating pressure

No.:	Description	Maximum operating pressure			Nominal diameter
					
630-02G	Connector (S-fitting, rotatable) with two ZAK [®] spigot ends for gas	-	-	10 bar	ZAK 46
630-03	Transition piece with two ZAK [®] sockets	16 bar	16 bar	10 bar	ZAK 46, ZAK 69*
630-04	Rotatable junction with ZAK [®] spigot end / socket	16 bar	16 bar	-	ZAK 46
630-05	with ZAK [®] spigot end and ZAK [®] socket, reduced	16 bar	16 bar	-	ZAK 34, ZAK 46, ZAK 69
630-05G	Transition with ZAK [®] spigot end and ZAK [®] socket, reduced for gas	-	-	10 bar	ZAK 34, ZAK 46
630-08	Transition fitting with ZAK [®] spigot end to [®] socket	16 bar	-	-	ZAK 34, ZAK 46

* ZAK 69 not suitable for gas

ZAK[®] system: Fittings



637-00
Transition fitting DCI pipe /
ZAK[®] socket



646-00
Rotating push-fit elbow 90° with
ZAK[®] spigot end and ZAK[®] socket



646-01
Rotating push-fit elbow 90°
with ZAK[®] spigot end



646-02
Rotating push-fit elbow 90° with
detachable taper ring and
ZAK[®] spigot end "Type N"



647-00
Elbow 90° with ZAK[®] spigot end
and ZAK[®] socket





647-00G
Elbow 90° with ZAK[®] spigot end
and ZAK[®] socket
for gas

Maximum operating pressure



No.:	Description	Maximum operating pressure			Nominal diameter
637-00	Transition fitting DCI pipe / ZAK [®] socket	16 bar	16 bar	-	ZAK 46 DN 40
646-00	Rotating push-fit elbow 90° with ZAK [®] spigot end and ZAK [®] socket	16 bar	16 bar	-	ZAK 46
646-01	Rotating push-fit elbow 90° with ZAK [®] spigot end	16 bar	16 bar	-	ZAK 34, ZAK 46 Pipe: d 25, 32, 40, 50, 63 mm
646-02	Rotating push-fit elbow 90° with detachable taper ring and ZAK [®] spigot end "Type N"	16 bar	16 bar	-	ZAK 34, ZAK 46 pipe: d 32, 40, 50 mm
647-00	Elbow 90° with ZAK [®] spigot end and ZAK [®] socket	16 bar	16 bar	-	ZAK 46
647-00G	Elbow 90° with ZAK [®] spigot end and ZAK [®] socket for gas	-	-	10 bar	ZAK 46

ZAK[®] system: Fittings





647-01
 Elbow 90° with ZAK[®] spigot end and push-fit socket







647-04
 Elbow 90° with ZAK[®] spigot end and PE-end







647-04G
 Elbow 90° with ZAK[®] spigot end and PE-end for gas





649-00
 Elbow 45° with ZAK[®] spigot end (ZAK 69) and push-fit socket

Maximum operating pressure

No.:	Description	Maximum operating pressure			Nominal diameter
					
647-01	Elbow 90° with ZAK [®] spigot end and push-fit fitting	16 bar	16 bar	-	ZAK 34, ZAK 46 Pipe: d 25, 32, 40, 50, 63 mm ZAK 69 Pipe: d 50, 63 mm
647-04	Elbow 90° with ZAK [®] spigot end and PE-end	16 bar	16 bar	-	ZAK 34, ZAK 46 Pipe: d 32, 40, 50, 63 mm
647-04G	Elbow 90° with ZAK [®] spigot end and PE-end for gas	-	-	10 bar	ZAK 34, ZAK 46 Pipe: d 32, 40, 50, 63 mm
649-00	Elbow 45° with ZAK [®] spigot end (ZAK 69) and push-fit socket	16 bar	16 bar	-	ZAK 69 pipe: d 50, 63 mm

ZAK® system: Fittings



649-01
Rotating push-fit elbow 45° with ZAK® spigot end and push-fit socket



651-00
Tee branch fitting with ZAK® sockets at all ends



651-01
Tee branch fitting with ZAK® socket and ZAK® spigot end



651-01G
Tee branch fitting with ZAK® socket and ZAK® spigot end for gas



651-02
TT piece ZAK 46/46



651-03
Connector with ZAK® outlet (ZAK 69), 45°

No.:	Description	Maximum operating pressure			Nominal diameter
649-01	Rotating push-fit elbow 45° with ZAK® spigot end and push-fit socket	16 bar	16 bar	-	ZAK 46 pipe: d 32, 40, 50 mm
651-00	Tee branch fitting with ZAK® sockets at all ends	16 bar	16 bar	10 bar	ZAK 46, ZAK 69*
651-01	Tee branch fitting with ZAK® socket and ZAK® spigot end	16 bar	16 bar	-	ZAK 46, ZAK 69
651-01G	Tee branch fitting with ZAK® sockets and ZAK® spigot end for gas	-	-	10 bar	ZAK 46
651-02	TT piece ZAK 46/46	16 bar	16 bar	10 bar	ZAK 46
651-03	Connector with ZAK® outlet (ZAK 69), 45°	16 bar	16 bar	-	ZAK 69 d 63 mm

* ZAK 69 not suitable for gas

ZAK[®] system: Fittings and pipe fittings

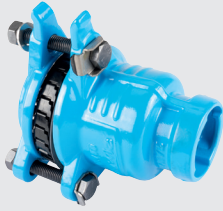

740-01
Synoflex transition piece
to ZAK[®] system



859-00
Wafer-type tee piece
with ZAK[®] outlets

Maximum operating pressure



No.:

Description

Nominal diameter

740-01

Synoflex transition piece
to ZAK[®] system

16 bar

16 bar

-

ZAK 46
Pipe: d 46 - 58, d 56 - 71 mm
ZAK 69
pipe: d 56 - 71 mm

859-00

Wafer-type tee piece
with ZAK[®] outlets

10/16 bar

-

-

Outlet: ZAK 46, ZAK 69
Pipe: DN 50 - DN 400

ZAK® system: Accessories



249-00
ZAK® plug



249-00G
ZAK® plug
for gas

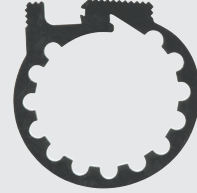

616-03
Locking ring for
ZAK® fittings

Maximum operating pressure

No.:	Description	Maximum operating pressure			Nominal diameter
249-00	ZAK® plug	16 bar	16 bar	-	ZAK 34, ZAK 46, ZAK 69
249-00G	ZAK® plug for gas	-	-	10 bar	ZAK 34, ZAK 46
616-03	Locking ring for ZAK® fittings	-	-	-	ZAK 34, ZAK 46, ZAK 69

Hawle app



Hawle app

The new Hawle app unites the analog and digital worlds. The Hawle app is our digital alternative to printed brochures, catalogues and price lists. Thanks to the new Hawle app, you can access all the latest materials on our extensive product portfolio quickly and easily. The content offered can be used both online and offline, allowing information to be retrieved even in the deepest dead zones.

The Hawle app provides you with quick access to the “Hawle media library”, the “Hawle product catalog”, “digital calipers” and the “Hawle customer portal”, making it easier to locate interactive content and digital services. You will find all the latest videos on our products in our integrated Hawle media library.

Using the integrated QR code and the EAN code scanner, you can now retrieve product information even faster and more accurately. What is more, all the information channels from the Hawle website and the Hawle social media channels are bundled together on the start screen of the app. This means you will always have the most important company news and information on our latest products at your fingertips. The integrated push notifications will inform you of any updates to documents in real time. Further information is available at www.hawle.de/en/downloads/hawle-app/hawle-app/

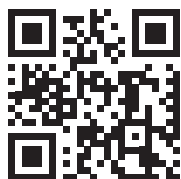

BIM data and Hawle CAD

BIM data provided by Hawle

As a manufacturer of heavy-duty fittings, we would like to support you in the effective and time-saving planning of your construction projects. For this reason, we have generated a “digital” version of the Hawle products from our standard range for your benefit. You can download our digital product data in more than 150 different file formats.

In addition to the digital geometry data, our digital product data also contains additional relevant information on the individual components, such as materials used, areas of application, operating pressures, etc.

With the BIM plugin, you can integrate our digital product data directly into your planning program. The BIM plugin was developed for all common planning programs such as ALLPLAN, Archicad, AutoCAD, Revit, BricsCAD, SketchUp (continuous expansion of the programs). After installing the plugin, all Hawle BIM assemblies are available to you directly in your installed planning program. You can quickly and easily add the desired products to your project from the library of your planning program using drag and drop.

Do you have any questions about our BIM data? Please send us a message to bim@hawle.de. For any further information, please see www.hawle.de/bim.

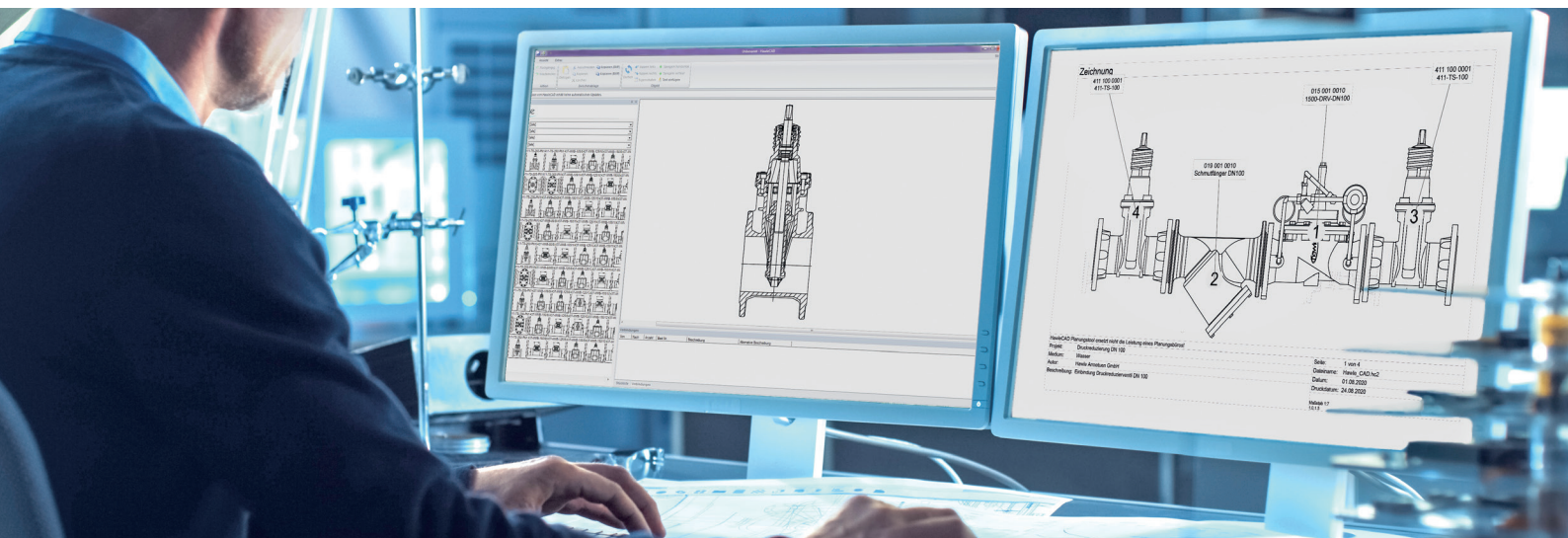
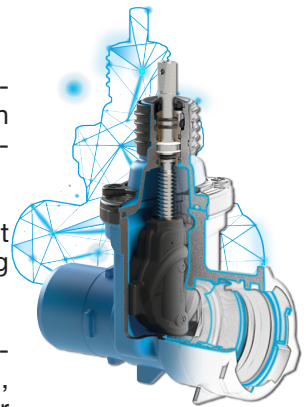

Hawle CAD

- Planning of valve sequences or nodes with parts list output (incl. matching accessories)
- Extensive expansion of various product groups (e.g. BAIO® system, ZAK® system, flange connections, control valve, etc.)
- Data export in DXF format and transfer to various planning programs possible (e.g. AutoCAD, etc.)
- Generation and direct transmission of enquiries based on drawings and parts lists possible



The Hawle CAD is available for download free of charge at: www.hawle.de/cad

Hawle Deutschland Armaturen GmbH
Liegnitzer Straße 6
83395 Freilassing
Deutschland

Tel.: +49 8654 6303-0

info@hawle.de
www.hawle.de/en



© For further information on our brands, please contact us at info@hawle.de or visit our website on www.hawle.de.
We deliver based on our familiar General Terms and Conditions of Sale (GTC), which are available for downloading.
All illustrations, technical data, dimensions and weights are non-binding. Subject to change. Last updated: 08/2026