

General Information

Threadless Connection Technology

Product Categories

1.1 BAIO [®] System	1-4
1.2 ZAK [®] System	1-12

1.1 BAIO[®] System



General Information Threadless Connection Technology

1.1 BAIO® System

For decades, the connection of pipes and pipe fittings in buried pipeline construction has been mainly effected via flangeless connections as this connection technology has both technical and economical advantages over conventional flanged and welded connections. In the past, threaded connections were used in the construction of service lines. The bare transition areas typical of in this way of connection were susceptible to contact corrosion causing incrustation which often permanently damaged the connection and the sealing.

Therefore, in the early 1980s, Hawle Armaturen GmbH developed the Hawle BAIO® system with a view to affording customers a simple and stress-relieved installation of pipeline elements and valves, while simultaneously ensuring a long service life of the system due to integral corrosion protection. This idea was also the basis of the Hawle ZAK® system for the service line sector to provide for a long service life of the service system in this field, too. Meanwhile, both connection technologies have become widely accepted as the state of the art.

These generally acknowledged advantages can be fully applied to the connection between pipelines and valves, as well as between valves. Beside the technical advantages of the threadless connection technology, the economic benefits of this push-fit socket technology must be emphasized. In case of the Hawle BAIO® system, the savings are due to the compact design facilitating storage and transport, as well as the considerably shorter installation times compared with conventional flanged and welded connections (see graphics on page 1-6).

This innovative idea resulted in a consistent threadless system from DN 25 to DN 300! For more than 30 years, this range of threadless products has been advanced and extended. You can find the threadless system in the following categories:

Section 1: Threadless Connection Technology

Section 3: Air Valves

Section 4: Hydrants

Section 6: Control valves

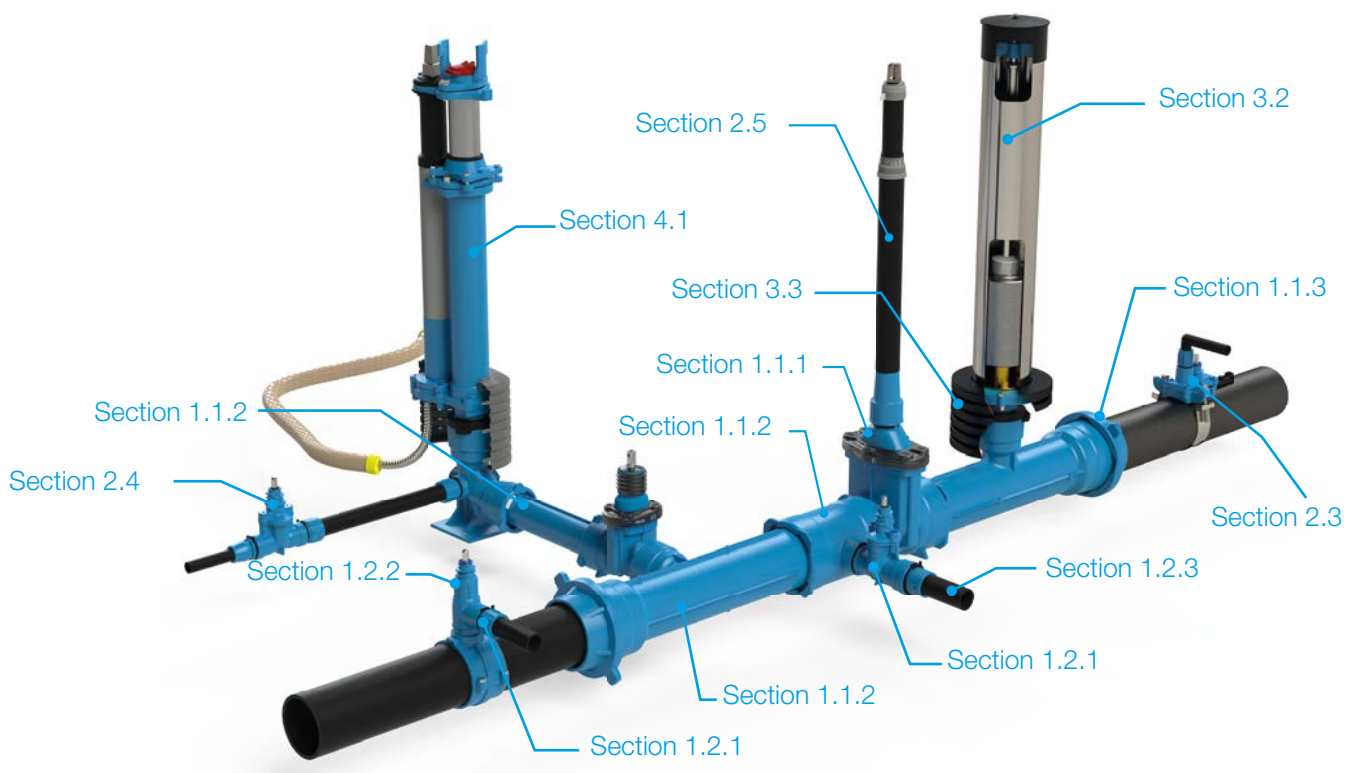

Design of a threadless connection system with a main line and two service lines.

General Information Threadless Connection Technology

1.1 BAIO® System

Threadless connection - BAIO® system

Locking and sealing

Establishing a form-locked connection of valves and pipe fittings in the BAIO® system is effected via a bayonet connection and requires only little force. Therefore, it is possible to use the system for CI pipes with BAIO® lip seal (BLD®), on the one hand, and with CI-plastic gasket (GKS) for PVC and PE pipes, on the other hand. Moreover, for PE and steel pipes there are components with a fusion tail for welding with the respective pipe ends. The longitudinally force-locked connection between the BAIO® components is positively established via the bayonet lock well known from a lot of technical fields.



Technical features BAIO® system

- Medium: potable water, sewage water, gas
(On ordering, please specify the medium and the type of pipe to ensure that the correct gasket is supplied.
Standard gasket: BAIO® lip seal for water)
- Nominal widths 80 - DN 300
- Max. operating pressure 16 bar
- Easy and time-saving installation
- Low number of components and connections
- Push-fit socket connection can be bended to all sides (up to 3° per spigot/socket connection)
- Stress-relieved when installed
- Low storage costs
- Restraint joint with Hawle Stop without the need for earthing
- Integral high-quality corrosion protection due to Hawle epoxy powder coating
- Universal use with CI, steel*, PE, PVC and AC** pipes
(* with steel welding tail 452-01,
** with cut-in socket fitting with Multi/Joint® socket 530-01)

Note regarding BAIO® system for gas

As special gaskets are required when used for gas applications, please make sure to specify "Use for gas" on your order! These gaskets are factory-mounted. Gas gaskets must be identified as such. Non-identified gaskets must not be used for gas applications.

The BAIO® system compared with flanged valves

Flanged system: 307 components



BAIO® system: 7 components









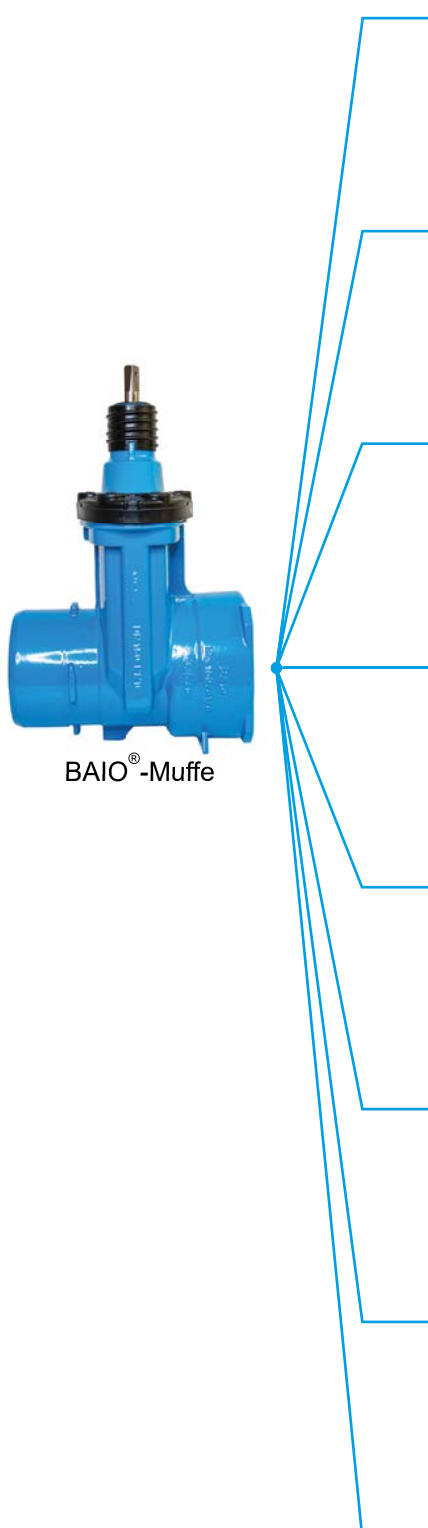

























General Information Threadless Connection Technology

1.1 BAIO® System

ONE push-fit socket – FOUR types of pipe: CI, PVC, PE, and steel pipe (use of steel welding tail 452-01). To establish a tight and longitudinally force-locked connection of pipes in BAIO® sockets, different gaskets and restraint joints have to be used, depending on the type of pipe. Please observe the following overview.









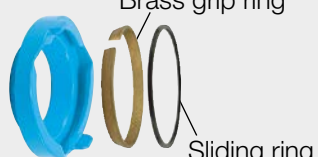

Gasket	Grip ring	Locking ring	Type of pipe
BLD® 	Segmented grip ring 	Hawle Stop 	CI pipe DN 80 - DN 200 
BLD® 	Express ring 	BAIO®-Sit 	CI pipe DN 250 - DN 300 
GKS 	Corundum grip ring 	Hawle-Stop 	PVC pipe DN 80 - DN 200 
GKS 	Brass grip ring  Sliding ring 	BAIO®-Sit 	PVC pipe DN 250 - DN 300 
GKS 	Interlocked grip ring 	Hawle-Stop 	Support liner PE/PEX pipe DN 80 - DN 200 
GKS 	Interlocked grip ring 	BAIO®-Sit 	Support liner PE/PEX pipe DN 250 - DN 300 
GKS 	Welding ring 	BAIO®-E-Stop 	Support liner PE pipe 
BBD 	Blutop-grip ring 	Hawle-Stop 	Blutop pipe 

General Information Threadless Connection Technology

1.1 BAIO® System

Installation of valves in the BAIO® system in connection with different types of pipes

Pipe	Gasket	Longitudinally force-locked connection (restraint joint)	
CI pipe (GGG) acc. to DIN EN 545 Steel pipes with CI pipe outside diameter	<u>Potable water / sewage:</u> BAIO® lip seal <u>Gas:</u> CI pipe gasket, gas-proof	CI pipe grip ring  528-00, Hawle-Stop (CI) DN 80 - DN 200	Express ring  527-00, BAIO®-Sit (CI) DN 250 - 300
PVC pipes acc. to DIN 8061/8062	<u>Potable water/ sewage:</u> GKS gasket <u>Gas:</u> GKS gasket, gas	 528-00, Hawle-Stop (PVC) DN 80 - DN 200	Brass grip ring Sliding ring  527-00, BAIO®-Sit (PVC) DN 250 - 300
PE pipe: PE 80, PE 100 acc. to DIN 8074/75 SDR 11 / 17 / 17.6 PE-X pipes acc. to DIN 16892/93 SDR 11 / 17 / 17.6 <i>In case of pipes with very smooth surfaces (e.g. PE-X pipes) we recommend roughening the pipe end in the area of the grip ring!</i>	<u>Trinkwasser/Abwasser:</u> GKS gasket	Interlocked grip ring  528-00, Hawle-Stop (PE), use of support liner (to be ordered separately!) DN 80 - DN 200	Interlocked grip ring  527-00, BAIO®-Sit (PE) Use of support liner (to be ordered separately!) DN 250 - 300
PE pipe: PE 80, PE 100 acc. to DIN 8074/75 SDR 11 / 17 / 17.6 PE-X pipes acc. to DIN 16892/93 SDR 11 / 17 / 17.6	<u>Potable water/ sewage:</u> BAIO® lip seal acc. to DVGW W 270 <u>Gas:</u> CI pipe gasket, gas-proof	 452-00, PE fusion tail with integral support liner and lock ring	
Steel pipe acc. to EN 10224 / DIN 2460	<u>Gas:</u> DN 80, DN 100, DN 150 and DN 200: CI pipe gasket, gas-proof DN 125: GKS gasket, gas-proof	 452-01, steel pipe welding tail with integral lock ring	
PE pipe: PE 80, PE 100 acc. to DIN 8074/75 SDR 11 / 17 / 17.6	<u>Potable water/ sewage:</u> GKS gasket	 528-01, restraint joint BAIO® E-stop for PE pipes	

Note: When connecting PE pipes, a support liner (Ord. No. 590) must be used.

General Information Threadless Connection Technology

1.1 BAIO® System

Schematic of a BAIO® spigot/socket connection

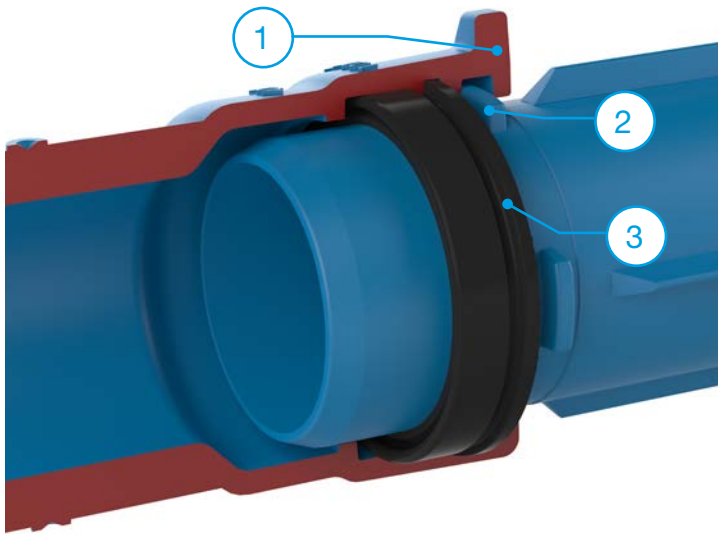

1. Bayonet lugs (for locking ring)
2. Locking lugs
3. BAIO® lip seal (standard gasket)

Schematic of a restraint connection in the BAIO® system by means of Hawle Stop

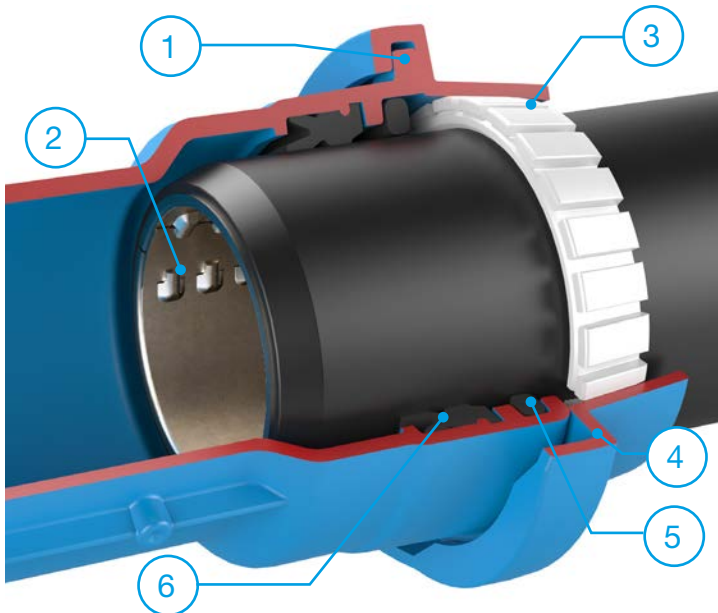

1. Bayonet lugs (for locking ring)
2. Support liner
3. Interlocked grip ring (for PE pipes)
4. Locking ring
5. Dirt gasket for socket
6. GKS gasket

General Information Threadless Connection Technology

1.1 BAIO® System

Installation of PE pipes DN 125 / d 125, DN 200 / d 200 and DN 250 / d 250 in BAIO® sockets

For the following nominal widths a supporting ring must be inserted into the BAIO® socket in addition to the GKS gasket to avoid the excessive bending of the pipe!

BAIO® socket DN	Pipe outside ø (d) mm	Position of supporting ring in BAIO® socket
125	125	At the back of the BAIO® socket
200	200	At the back of the BAIO® socket
250	250	At the front and back of the BAIO® socket

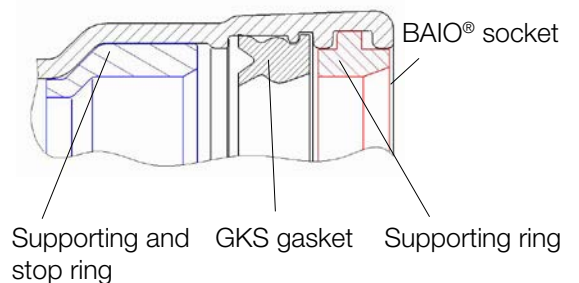
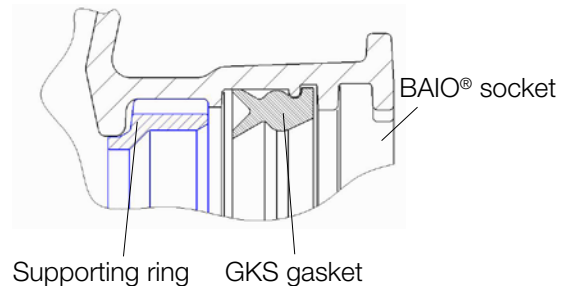

Installation of PE pipes DN 100 / d 125, DN 150 / d 180 in BAIO® sockets

The connection of PE pipes d 125 in BAIO® sockets DN 100 and/or PE pipes d 180 in BAIO® sockets DN 150 is possible only in combination with special SM fittings (Ord. No. 532-00). In these SM fittings, the GKS gasket is already factory-mounted.

Moreover, for the pipe outside diameter d 180 the spigot socket valve DN 150 / d 180 (4511501801) can be used. The spigot end of this gate valve fits into the all socket tees specifically developed for this purpose (5421501800, 5421801500, 5421801800).

Accessories in the Hawle BAIO® system

In the following, you will find useful products supplementing the Hawle BAIO® system.

Dirt gasket for sockets (529-04)

When connecting plastic pipes in BAIO® sockets and in case of very clayey or sandy soils we recommend the use of the dirt gasket for sockets to avoid any impairment of the sealing effect because of dirt washed in or pressed in during installation.

The dirt gasket for sockets is to be inserted into the ring gap in front of the GKS gasket before installing the pipe.

Explanation of the image (right):

- 1: Hawle-Stop, 2: Grip ring, 3: GKS gasket,
- 4: BAIO® socket, 5: Dirt gasket, 6: Plastic pipe, chamfered (PE or PVC)

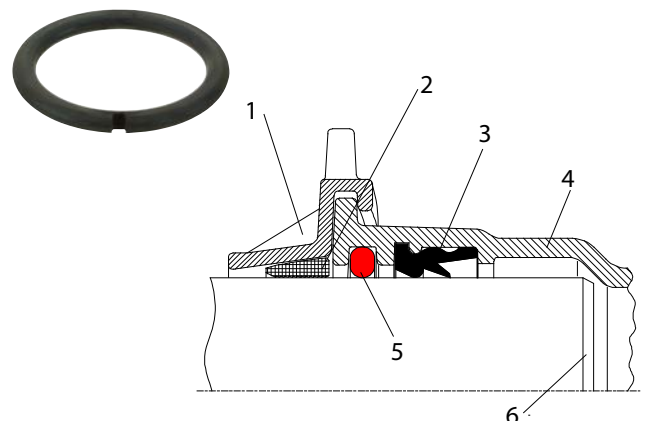

General Information Threadless Connection Technology

1.1 BAIO® System



Dirt cover and locking ring (490-05)

All vertical BAIO® connections such as hydrants, air valve assemblies, and pipe fittings (e.g. vertically installed SM fitting) with BAIO® spigot ends have to be secured against unintentional unlocking by means of a dirt cover and locking ring.

Twist-lock device for BAIO® spigot/socket connection (529-05)

The twist-lock device prevents the unintentional unlocking of BAIO® spigot/socket connections, e.g. in case of extensive preliminary installation work outside the trench.

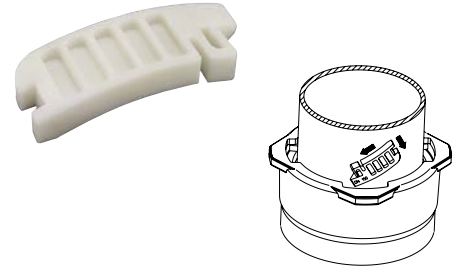

Figure: Transition fitting BAIO® spigot end DN 80 to ZAK® socket (ZAK 46)

Transition fittings to nominal widths smaller than DN 80

In case of form-locked transitions to nominal widths smaller than DN 80, for example, the transition adaptor with BAIO® spigot end DN 80 and ZAK® socket ZAK 46 and/or ZAK 69 shall be used. In the ZAK® system, valves, pipe fittings and fittings are locked by means of a bayonet connection similar to the one used in the BAIO® system. Detailed information about the ZAK® system is given on the following pages. For more information on our fittings please refer to Section 5.

General Information Threadless Connection Technology

1.1 ZAK® System

Threadless connection - ZAK® system

Locking and sealing

For installation, it is sufficient to push the ZAK® spigot end into the ZAK® socket, to lock it by turning it 90° clockwise, and to pull it back as far as it will go. To engage the ZAK® spigot end into the ZAK® socket, the connection has to be secured against unintentional unlocking by means of a locking ring.

The connection is reliably sealed via the bayonet connection consisting of a corrosion protected socket with inside bayonet locking and a spigot end with locking keys, also corrosion protected, plus a double O-ring gasket.



Technical features

- Medium: potable water, sewage water, gas
- Nominal widths:
 - ZAK 34 – corresponding to dimension 1”
 - ZAK 46 - corresponding to dimension 1 ½“
 - ZAK 69 - corresponding to dimension 2”
- Max. operating pressure: potable water 16 bar, sewage water 16 bar (gas on request)
- Easy and quick installation
- Threadless connection technology
- Stress relief due to movability of the connection
- Reliable double O-ring sealing of the connection
- Long service life due to integral corrosion protection
- No tools required for installation

Drilling in the ZAK® system

Via a Hawle pipe drilling saddle, in-service drilling of the line is possible up to a maximum operating pressure of 16 bar.

By means of the Hawle drilling device “Hawloamat” (see Section 7) you can drill CI, steel, PVC, PE, and AC pipes via a pipe drilling saddle, e.g. in the ZAK® system. Both potable water and sewage water lines can be drilled. For the field of sewage water, the ZAK 69 system has been developed specifically. The drilling of a Hawle free-flow underground hydrant installed later is also possible. To this end, an extra-long drill spindle with claw adapter has to be used. (For more information on the Hawle pipe drilling saddles please refer to Section 2.)



Application in the field of potable water

Drilling of an existing PE supply line by means of HAKU Hawlinger ZAK 46

Details see page 2-19



Application in the field of sewage water

Drilling of a waste pipe through a sewage water service valve ZAK 69 with HAKU pipe saddle

For more information on our drilling device Hawloamat and/or our loan units please refer to Section 7.