

On/Off valve for electrical remote control stepwise working - closed without current®



## **HAWIDO - REGULATING VALVES**

Instruction for

**On/Off valve for electrical  
actuation works step-by-step –  
without current – hydraulically closed  
Type 1795**

**ND40 - ND200**



Keep this instruction manual at the location of the valve!

Example of rating plate

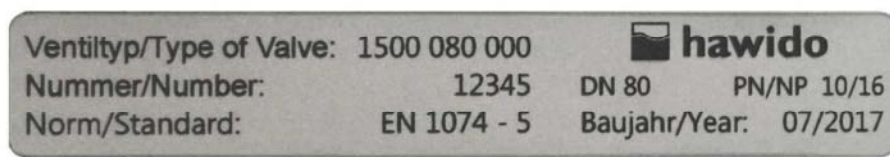

After the commissioning, enter the following data and make use of this additional information regarding the valve type, pressure and flow ratios when consulting the manufacturer or the supplier or asking them questions:

Serial number: ..... DN ..... PN: .....

Year of manufacture:.....

# CONTENTS

<b>A. DESCRIPTION</b>	<b>2</b>
1. FUNCTION	2
2. GENERAL SAFETY INSTRUCTIONS	3
3. RECOMMENDED INSTALLATION	3
<b>B. COMMISSIONING</b>	<b>4</b>
1. FUNCTIONAL DIAGRAM (1795)	4
2. PREPARATORY WORK	4
3. VENTING	5
4. COMMISSIONING THE VALVE AND THE CONTROL SYSTEM	5
5. SETTING THE REACTION SPEED	5
6. CHECKING FOR LEAKAGE	5
<b>C. FAULT FINDING</b>	<b>6</b>
<b>D. PUTTING OUT OF SERVICE AND MAINTENANCE</b>	<b>7</b>
1. PUTTING OUT OF SERVICE	7
2. MAINTENANCE AND SERVICE	7
2.1 GENERAL INFORMATION	7
2.2 ANNUAL FUNCTIONAL CHECKS	7
2.3 4 TO 5-YEAR MAINTENANCE	8
3. REPAIR KITS AND SPARE PARTS	9
3.1 BASE VALVE DN 40 TO DN 200 (DRAWING)	10
3.2 MAIN VALVE (PARTS LIST)	11
3.3 CONTROL LINE INDIVIDUAL PARTS AND ACCESSORIES	13
<b>E. ANNEX</b>	<b>18</b>
1. TORQUES	18
<b>F. HAWLE IN EUROPE</b>	<b>19</b>



## 2. General safety instructions

These instructions must be read through carefully and understood before starting the commissioning. Damage to property and injuries to persons could occur as a result of improper installation, commissioning, operation and maintenance.

The Hawle regulating valve (HAWIDO) has been designed for use in drinking water supplies. Other application media only after consultation with the manufacturer.

The technical regulations (e.g. SVGW, ÖVGW, DVGW...) and codes of practice (e.g. VDE, VDI ...), laws and standards are taken as a minimum standard, and must be adhered to and applied.

Work on electrical installations and parts (e.g. installation of electrical position indicators, solenoid valves, etc.) may only be carried out by personnel authorised for this work.

In principle, the responsibility for the layout, the installation position, the installation and the commissioning of the fittings in the pipe work lies with the designer, the installation company and/or the operator. Design or installation errors can adversely affect the safe operation of the regulating valve, and can represent a significant risk. Please consult us in case of doubt.

## 3. Recommended installation

Before the installation of the fitting, the pipe lines must be carefully blown or flushed through to prevent any foreign material, such as pieces of wood, stones etc., from entering the regulating valve.

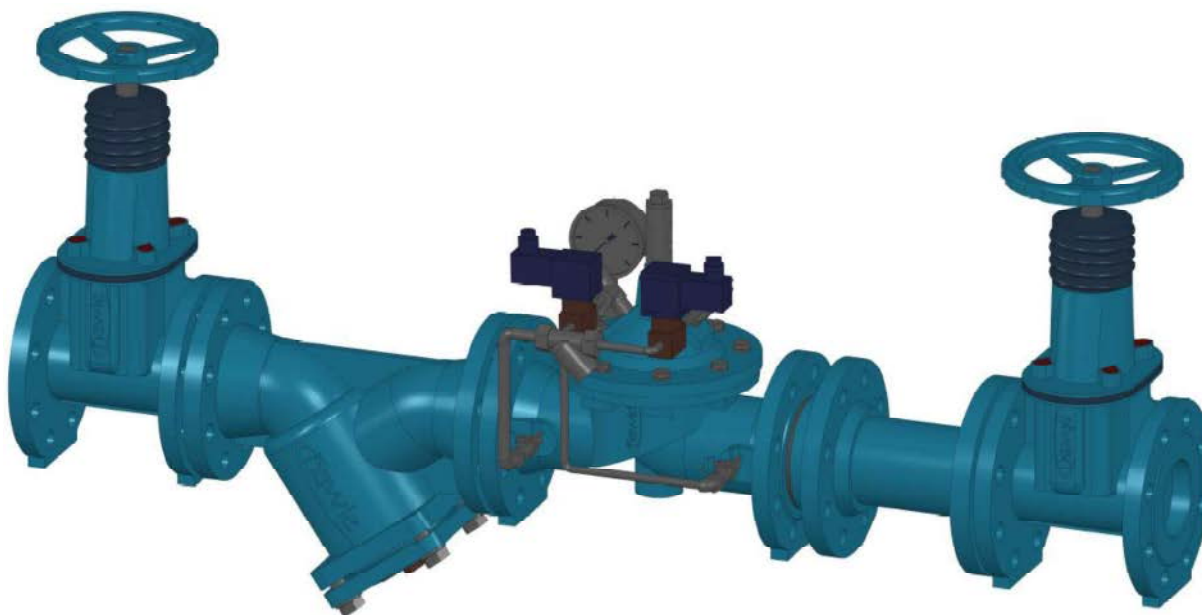

The HAWIDO must be installed horizontally with the valve cover upwards (other models available on request). We recommend that a gate valve and a dirt trap be fitted in front of the valve, as well as the mounting of a gate valve at the outlet. Before the installation, check that no coarse foreign objects can penetrate into the HAWIDO.

Please contact us for other types of installation.

## B. Commissioning

### 1. Functional diagram (1795)

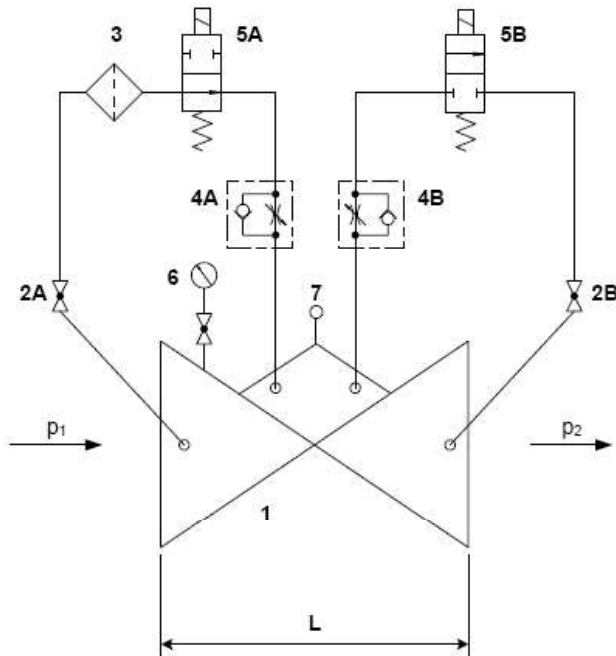

#### Components

- 1 Main valve 1200
- 2 Ball valve (A, B, C)
- 3 Filter
- 4 One-way flow restrictor (A, B)
- 5 Solenoid valve (A, B)
- 6 Pressure gauge with ball valve
- 7 Optical position indicator  
(optional) Electrical position indicator  
(optional) analogue position indicator  
(optional)  
Valve opening limiter (optional)

### 2. Preparatory work

Before commissioning the valve, check that the gate valves on the inlet and outlet sides of the valve are **closed** and that the flange connections have been correctly tightened and sealed.

#### On the valve:

- Open the ball valve (2C)
- Loosen the lock nut on the adjusting screw on the one-way flow restrictors (4A and 4B)
- Unscrew the adjusting screws on the one-way flow restrictors (4A and 4B) by approximately 10 turns. (The line to the control chamber is open).
- Close the ball valve (2B)
- Loosen the threaded pin in the central plug by a few turns.
- Slightly loosen a union of the control line at its highest point (approximately one turn).
- Remove power from the solenoid valves.

#### Caution:

Work on electrical installations and parts (e.g. installation of electrical position indicators, solenoid valves, etc.) may only be carried out by personnel authorised for this work.

### 3. Venting

**Procedure:**

Screw in the plug on the valve cover until approx. one turn before the sealing point.

**Slowly** open the inlet gate valve on the inlet side until water flows into the valve.

Once the valve venting procedure has caused all the air to be expelled from the control line, retighten the plug screw and the loosened union. Check that all the fittings are properly sealed, and re-tighten if necessary.

**Check:** If the shut-off gate valve on the outlet side is slightly opened, the valve should close or remain closed. Then close the shut-off gate valve again.

If the valve does not close, the commissioning procedure must be repeated from the previous chapter. Particular care must then be taken to ensure that the upper valve chamber and control lines are properly vented.

### 4. Commissioning the valve and the control system

The supplied electrical control system is commissioned by the **customer**.

**On the valve:**

- **Slowly** open the ball valve (2B)
- **Slowly** open the shut-off gate valve on the outlet side.
- Check electrical functions. The required flow rate can be regulated according to the one-way flow restrictor settings (4A and 4B; according to the following chapter) and the electrical actuations of the solenoid valves (5A and 5B). The base valve is locked hydraulically, if the solenoid valve (5A) is energised and solenoid valve (5B) is voltage-free

### 5. Setting the reaction speed

If the HAWIDO does not operate quietly, or if pressure shocks occur in the supply network, this can be corrected by the corresponding adjustment of the one-way flow restrictor (4A and 4B).

Strongly throttled one-way flow restrictors (4A and 4B) permit longer impulse times (contact the Hawle Company for basic settings of impulse and pause lengths).

**Procedure:**

Loosen the locknut. Screw in the set screw clockwise with a screwdriver until the valve operates quietly. Then retighten the locknut.

**Caution**

The setting screw must always remain at least 4 - 5 turns open, otherwise the valve will not reopen after the closing sequence. A special setting is necessary for very high inlet pressures.

### 6. Checking for leakage

The HAWIDO's are tested at the factory for both leakage and function before delivery. When checking for leakage under operational conditions, particular attention must therefore be given to the seals of the flange connections, the control line and the central plug screw on the valve cover. Where necessary, ensure the seal by retightening the connections.

**Notes:**

---

---

---

---



## C. Fault finding

Symptoms	Possible cause	Action
Valve does not open	One-way flow restrictor blocked	Replace, or unscrew the set screw several times until the valve functions properly
	One-way flow restrictor closed too far	Unscrew the set screw until the valve functions properly
Valve does not close	One-way flow restrictor blocked	Replace, or screw the set screw fully in and out several times and then re-set
	Filter in the control line blocked	Clean the filter
	Air in the control line / upper valve chamber	Vent
	Foreign matter in the main valve	Carry out service and remove any foreign matter
	Diaphragm defective	Carry out a service. Replace the diaphragm
	Valve spindle jammed by encrustation	Carry out service and remove any encrustation
Loud noise	Unfavourable operating conditions	Change pressure by approx. 0.1 to 0.2 bar. Slightly open or close the one-way flow restrictor. Contact the Hawle Customer Service department.
	Wrong valve size	Have the correct valve size calculated (contact Hawle)
Erratic operation	One-way flow restrictor incorrectly set	Reset (according to section setting the reaction speed)
	Changed operating conditions	Reset (see Setting-up paragraph)
EWS coating damaged	Transportation damage, installation damage	Repair with Hawle two-component repair set for coatings

## D. Putting out of service and maintenance

### 1. Putting out of service

**Comment:** Electrical work may only be carried out by qualified technical personnel. Power must be removed from the solenoid valves. The valve closes. Then:

- **Slowly** close the gate valves before and after the valve
- **Slowly** close the ball valves.

For further work on the HAWIDO valve, the voltage must be interrupted to the solenoid valves. The valve has now been taken out of operation, and a service can be carried out.

### 2. Maintenance and service

#### 2.1 General information

Through our many years of experience with diaphragm valves that are controlled by the flow medium, we know that our HAWIDOs normally function trouble-free for many years. Regular maintenance is a precondition for this, however.

Under normal operating conditions, the following should be carried out:

- The valve should be checked for correct operation once a year (functional check)
- The dirt trap upstream of the valve and the filter in the control line should be cleaned once a year
- The inner working components should be checked and worn parts be replaced every four to five years (maintenance).

Under unusual operating conditions (e.g. with water that contains quantities of suspended matter, very high pressure reduction, small flow rates etc.), the functional checks and the service work should be carried out more frequently.

**Maintenance sign:**

Funktionskontrolle: jährlich	Wartung:
Contrôle fonctionnel: annuel	Maintenance: 20xx
Prova di funzionamento: ogni anno	Mantenzione:
Function check: annually	Maintenance:

xx stands for the respective year.

#### 2.2 Annual functional checks

##### Cleaning the dirt trap in the main line

- Unscrew the lid
- Clean filter (use soft brushes, cloths or similar), or possibly replace filter
- Install the filter and screw the lid back on

##### Cleaning the filter in the control line

- Unscrew the lid of the filter
- Clean filter (use soft brushes, cloths or similar), or possibly replace filter
- Re-install the filter and screw the filter lid back on

- **Checking the valve**
- Remove the vent plug or assembled accessories from the valve cover.
- Check that the valve spindle moves easily by raising and lowering it with the threaded rod. Special attention must be paid to this test procedure, above all with valves with modified counter seats.

#### **Putting back into service**

- according to Commissioning paragraph

#### **Functional check of the valve**

- The function of the valve can be checked by actuating the solenoid valves (according to table in section *Principle of operation*).

## **2.3 4 to 5-year maintenance**

#### **Cleaning the dirt trap in the main line**

- Unscrew the lid
- Clean filter (use soft brushes, cloths or similar), or possibly replace filter
- Install the filter and screw the lid back on

#### **Cleaning the filter in the control line**

- Unscrew the lid of the filter
- Clean filter (use soft brushes, cloths or similar), or possibly replace filter
- Re-install the filter and screw the filter lid back on

#### **Base valve (see chapter: *Repair kits and spare parts*)**

- Loosen the screw connections and remove the complete control line.
- Dismantle the optical position indicator or assembled accessories and replace the gaskets.
- Undo the screws of the valve cover and remove the cover.
- Visually inspect all inner components for wear, dirt and scaling
- Clean the inner components, the seat and the inner surfaces, including the cover
- Dismantle the spindle guide in the body, flush the body interior.  
For valves DN 40 to DN 100 (from 2012 on) and DN 125 to DN 200 (from 2014 on) the spindle guide is dismantled from the inside. Here the thread of the spindle guide and the base valve must be **extremely clean**. Grease the thread thoroughly (e.g. Foodgrease Aqua, Art. no. 5292, see chapter "Control line individual parts and accessories").
- Replace the diaphragm, the O-ring and the seat seal.
- Grease the spindle guide area with a grease suitable for contact with food (e.g. Foodgrease Aqua). Check the easy movement of the spindle by lifting and lowering with the spindle lifting tool (article number 1199, see chapter "Control line individual parts and accessories").
- Reassemble the base valve (see table in the annex for torques). During the assembly, the easy movement of the spindle must be checked with the spindle lifting tool by lifting and lowering **several times**.

#### **Functional check of the one-way flow restrictor**

- Undo the locknut
- Screw in the throttle screw, and then unscrew it as far as it goes
- Screw in again a few turns. This process must be easy and meet little resistance

#### **Checking the valve**

- Remove the vent plug or assembled accessories from the valve cover.
- Check that the valve spindle moves easily by raising and lowering it with the threaded rod. Special attention must be paid to this test procedure, above all with valves with modified counter seats.

#### **Putting back into service**

- see Commissioning chapter

#### **Functional check of the valve**

- The function of the valve can be checked by actuating the solenoid valves (according to table in section *Principle of operation*).

### **3. Repair kits and spare parts**

Several replacement parts are required for the 4 or 5 - year service. These can be obtained as a repair kit for:

- the main valve
- the control valve
- the control line
- the optical position indicator

The article numbers can be found in the part lists and the lists of spare parts.

#### **Caution:**

When ordering replacement parts, always specify the valve type, serial number and year of construction!

#### **Important:**

Replacement parts made of EPDM (diaphragms, seals) and NBR (O-rings) must be stored in a dark place, protected from UV radiation!

Shelf-life when stored in the dark:

EPDM 8 years from date of manufacture

NBR 5 years from date of manufacture

### 3.1 Base valve DN 40 to DN 200 (drawing)

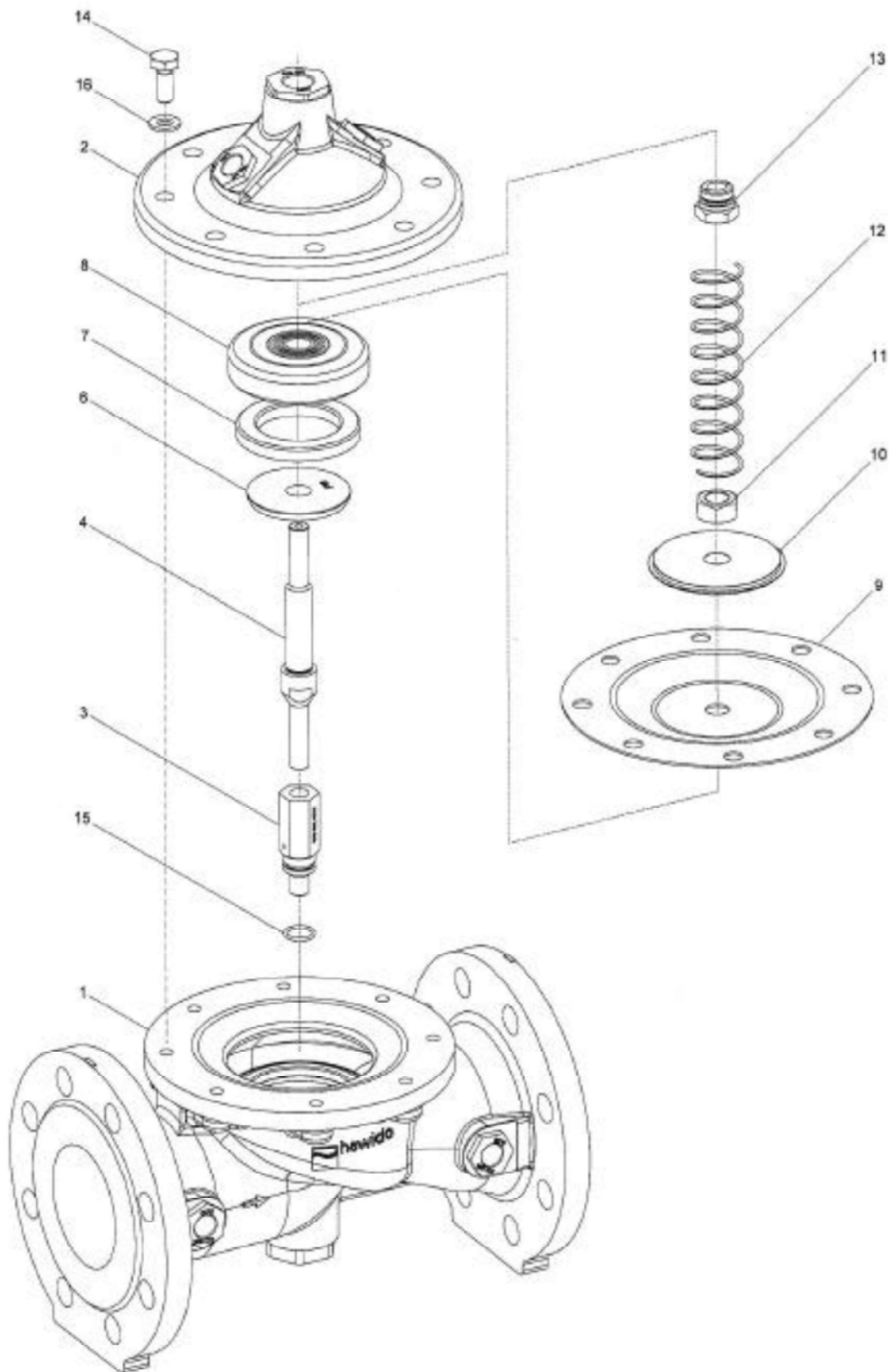

08.12.2011/plü

### 3.2 Main valve (Parts list)

Item.	Description	Material	Article number				
			DN 40	DN 50	DN 65	DN 80	DN 100
1	Body	GGG 40	1004 040 000	1004 050 000	1004 065 000	1004 080 000	1004 100 000
2	Valve cover	GGG 40	1014 050 000	1014 050 000	1014 065 000	1014 080 000	1014 100 000
3	Spindle guide cover	INOX	1024 900 000	1024 900 001	1024 900 002	1024 900 003	1024 900 004
4	Spindle	INOX	1026 050 000	1026 050 000	1026 065 000	1026 080 000	1026 100 000
5	Seat	INOX	*	*	*	*	*
6	Counter seat	INOX	1044 040 001	1044 050 001	1044 065 001	1044 080 001	1044 100 001
7	Seal	EPDM	1022 040 000	1022 050 000	1022 065 000	1022 080 000	1022 100 000
8	Seal carrier	INOX	1027 040 200	1027 050 200	1027 065 200	1027 080 200	1027 100 200
9	Diaphragm PN10/16	EPDM	1020 050 000	1020 050 000	1020 065 000	1020 080 000	1020 100 000
	Diaphragm PN25	EPDM	1020 050 000	1020 050 000	1021 065 000	1021 080 000	1021 100 000
10	Pressure disc	INOX	1047 050 000	1047 050 000	1047 065 000	1047 080 000	1047 100 000
11	Nut	INOX	0007 710 080	0007 710 080	0007 712 080	0007 716 080	0007 716 080
12	Spring	INOX	1049 050 000	1049 050 000	1049 065 000	1049 080 000	1049 100 000
	Spring for valves installed upright position	INOX	1050 050 000	1050 050 000	1050 065 000	1050 080 000	1050 100 000
13	Spindle guide cover	INOX	1042 900 000	1042 900 000	1042 900 001	1042 900 002	1042 900 002
14	Hexagonal screw	INOX	0006 608 020	0006 608 020	0006 610 025	0006 610 025	0006 612 025
15	O-ring	NBR	0180 012 020	0180 012 020	0180 012 020	0180 016 020	0180 016 020
16	Washer	INOX	0008 208 000	0008 208 000	0008 210 000	0008 210 000	0008 212 000
17	GSK-sticker		1099 900 000	1099 900 000	1099 900 000	1099 900 000	1099 900 000
18	Maintenance sticker		9691 0xx 000	9691 0xx 000	9691 0xx 000	9691 0xx 000	9691 0xx 000
	Main valve complete	PN10/16	1201 040 000	1201 050 000	1201 065 000	1201 080 000	1201 100 000
	Main valve complete	PN25	--	--	1201 065 025	1201 080 025	1201 100 025
	Repair kit for main valve with stainless steel connection, comprising item 7, 9, 15, 18	PN10/16	1080 040 000	1080 050 000	1080 065 000	1080 080 000	1080 100 000
		PN25	1080 040 000	1080 050 000	1081 065 000	1081 080 000	1081 100 000

Item	Description	Material	Article number			
			DN 125	DN 150	DN 200°	DN 200^
1	Body	GGG 40	1004 125 000	1004 151 000	1004 200 000	1004 200 016
2	Valve cover	GGG 40	1014 125 000	1014 151 000	1014 200 000	1014 200 000
3	Spindle guide cover	INOX	1024 900 005	1024 900 005	1024 900 006	1024 900 006
4	Spindle	INOX	1026 125 000	1026 151 000	1026 200 000	1026 200 000
5	Seat	INOX	*	*	*	*
6	Counter seat	INOX	1044 125 001	1044 150 001	1044 200 001	1044 200 001
7	Seal	EPDM	1022 125 150	1022 151 000	1022 200 000	1022 200 000
8	Seal carrier	INOX	1027 125 200	1027 151 200	1027 200 200	1027 200 200
9	Diaphragm PN10/16	EPDM	1020 125 150	1020 151 000	1020 200 000	1020 200 000
	Diaphragm PN25	CR	1051 125 150	1051 151 000	--	1034 200 000
10	Pressure disc	INOX	1047 125 150	1047 151 000	1047 200 000	1047 200 000
11	Nut	INOX	0007 720 080	0007 720 080	0007 724 080	0007 724 080
12	Spring	INOX	1049 125 150	1049 151 150	1049 200 000	1049 200 000
	Spring for valves installed upright position	INOX	1050 125 150	1050 151 000	1050 200 000	1050 200 000
13	Spindle guide cover	INOX	1042 900 003	1042 900 003	1042 900 004	1042 900 004
14	Hexagonal screw	INOX	0006 616 035	0006 616 035	0006 620 045	0006 620 045
15	O-ring	NBR	0180 018 020	0180 018 020	0180 021 020	0180 021 020
16	Washer	INOX	0008 216 000	0008 216 000	0008 220 000	0008 220 000
17	GSK-sticker		1099 900 000	1099 900 000	1099 900 000	1099 900 000
18	Maintenance sticker		9691 0xx 000	9691 0xx 000	9691 0xx 000	9691 0xx 000
21	Retaining bracket	INOX	--	--	1200 900 020	1200 900 020
	Main valve complete	PN10/16	1201 125 000	1201 151 000	1201 200 000	1201 200 016
	Main valve complete	PN25	1201 125 025	1201 151 025		1201 200 025
	Repair kit for main valve with stainless steel connection, comprising item 7, 9, 15, 18	PN10/16	1080 125 150	1080 151 000	1080 200 000	1080 200 000
		PN25	1081 125 150	1081 151 000		1081 200 000

° PN10

^ PN16

\* not interchangeable



16.03.2018/plü

### 3.3 Control line individual parts and accessories



Master number Designation	Picture	Size further sizes possibly available	Art. number
<b>0130</b> Compound seal		Stainless steel/NBR 3/8" Stainless steel/NBR 1/2" Stainless steel/NBR 3/4" Steel/NBR 1"	0130 012 000 0130 016 000 0130 025 000 0130 032 000
<b>0273</b> Individual parts		Fitting connection (consisting of: connector nut and clamping ring) DN 12 stainless steel  connector nut only	0273 012 000  0274 xxx xxx
<b>0275</b> Support sleeve		Stainless steel d4 – 6 Stainless steel d12 – 9 Stainless steel d12 – 10	0275 006 004 0275 012 009 0275 012 010
<b>0283</b> Clamping ring		d6 Stainless steel d12 Stainless steel d18 Stainless steel d8 - 6 Stainless steel	0283 006 000 0283 012 000 0283 018 000 0283 008 006
<b>0284</b> Orifice plate  (Old orifice plate number 0281.		d12 Stainless steel Ø 0.6 mm d12 Stainless steel Ø 0.9 mm d12 Stainless steel Ø 1.2 mm d12 Stainless steel Ø 1.5 mm d12 Stainless steel Ø 1.9 mm d12 Stainless steel Ø 2.4 mm d12 Stainless steel Ø 3.1 mm d18 Stainless steel Ø 3.5 mm d18 Stainless steel Ø 4.0 mm	0284 006 000 0284 009 000 0284 012 000 0284 015 000 0284 019 000 0284 024 000 0284 031 000 0284 035 010 0284 040 010
<b>0311</b> fitting with screw-in nipple		d 12 - 3/8" Stainless steel d 12 - 1/2" Stainless steel d 6 - 1/8" Stainless steel d 6 - 1/4" Stainless steel d 6 - 3/8" Stainless steel d18 – 1/2" Stainless steel	0311 012 012 0311 012 016 0311 006 004 0311 006 008 0311 006 012 0311 018 016
<b>0323</b> Straight fitting		d 6 Stainless steel d 12 Stainless steel	0323 006 000 0323 012 000
<b>0324</b> Straight socket end fitting		d12 - 3/8"	0324 012 012
<b>0351</b> Reduction fitting		d6 – d12 stainless steel	0351 012 006
<b>0361</b> Transition sleeve		d 10 - 3/8" Stainless steel d 12 - 3/8" Stainless steel d 12 - 1/2" Stainless steel d 18 – 1/2" Stainless steel	0361 010 012 0361 012 012 0361 012 016 0361 018 016
<b>0371</b> Reduction nipple		IG d 12 – AG 3/8" Stainless steel	0371 012 012







<b>0401 Sleeve</b>		3/8" Stainless steel 1/2" Stainless steel 3/4" Stainless steel 1" Stainless steel	0401 012 000 0401 016 000 0401 025 000 0401 032 000
<b>0411 Adjuster nipple</b>		DN 6 - 1/8" Stainless steel DN12 - 3/8" Stainless steel	0411 006 004 0411 012 012
<b>0431 Screw-in elbow</b>		DN 6 - 1/8" Stainless steel DN6 - 1/4" Stainless steel DN12 - 3/8" Stainless steel DN18 - 1/2" Stainless steel	0431 006 004 0431 006 008 0431 012 012 0431 018 016
<b>0431 Screw-in elbow with vent</b>		DN 123/8" Stainless steel	0431 012 013
<b>0451 Angled fitting</b>		DN6 Stainless steel DN12 Stainless steel DN18 Stainless steel	0451 006 000 0451 012 000 0451 018 000
<b>0452 90° Adjuster elbow</b>		DN12	0452 012 000
<b>0455 Connector elbow</b>		IG 3/8" Stainless steel IG 1/2" Stainless steel IG 3/4" Stainless steel IG 1" Stainless steel	0455 012 000 0455 016 000 0455 025 000 0455 032 000
<b>0456 Connector elbow</b>		IG 3/8" - AG 3/8" Stainless steel IG 1/2" - AG 1/2" Stainless steel IG 3/4" - AG 3/4" Stainless steel IG 1" - AG 1" Stainless steel	0456 012 000 0456 016 000 0456 025 000 0456 032 000
<b>0461 T-piece</b>		d6 Stainless steel d12 Stainless steel d12 - 6 - 12 Stainless steel d18 stainless steel	0461 006 000 0461 012 000 0461 012 006 0461 018 000
<b>0510 Plug</b>		AG 3/8" conical stainless steel AG 1/2" conical stainless steel	0510 012 000 0510 016 000
<b>0511 Vent plug, Lock screw</b>		AG 1/2" Stainless steel AG 3/4" Stainless steel AG 1" stainless steel with hexagon socket	0511 016 000 0511 025 000 0511 032 001
<b>0520 hexagon double nipple</b>		d 1/8" Stainless steel d 1/4" Stainless steel d 3/8" Stainless steel d 1/2" Stainless steel d 3/4" Stainless steel	0520 004 000 0520 008 000 0520 012 000 0520 016 000 0520 025 000
<b>0541 Ball valve</b>		DN 3/8" stainless steel DN 1/2" stainless steel DN 3/4" stainless steel	0541 012 001 0541 016 000 0541 016 010

<p><b>0545</b> <b>Stainless steel dirt filter</b></p>		<p>Stainless steel Y-filter IG 3/8" Individual parts: Stainless steel dirt filter Plug, complete for Y-filter, stainless steel Large seal for Y-filter, POM Small O-ring for plug</p>	<p>0545 112 002  0545 900 051 0545 112 010 0545 112 011 0545 112 012  0545 116 000</p>
<p><b>0549</b> <b>Flow control valve &amp; check valve</b></p>		<p>DN 3/8" Check valve brass nickel-plated  Stainless steel IG 3/8" type B d 12 with long spindle</p>	<p>0549 000 002  0549 000 005</p>
<p><b>0570</b> <b>Non-return valve</b></p>		<p>3/8" brass (max. 40 bar) 1/2" brass (max. 40 bar)</p>	<p>0570 012 045 0570 016 045</p>
<p><b>0600</b> <b>Pressure gauge</b></p>		<p>AG 3/8" 0 - 6 bar AG 3/8" 0 - 10 bar AG 3/8" 0 - 16 bar AG 3/8" 0 - 25 bar AG 3/8" 0 - 40 bar AG 3/8" 0 - 60 bar</p>	<p>0600 012 006 0600 012 010 0600 012 016 0600 012 025 0600 012 040 0600 012 060</p>
<p><b>0610</b> <b>Solenoid valves</b></p>		<p>Solenoid valve, normally open 2/2-way valve (for 1795/96) <b>122K84</b></p> <p>Solenoid valve, normally closed 2/2 way valve (for 1795/96) <b>E121K04</b></p> <p>Solenoid valve, normally open 3/2 way valve (for 1703 to DN 100 1603, 1706 PN 16 all nominal sizes) <b>132K04</b></p> <p>Solenoid valve normally closed 3/2 way valve (for 1704 to DN 100, 1604) <b>E131K04</b></p> <p>Solenoid valve normally open 2/2 way valve (for 1704 from DN 125 1304, 1404, 1504) (old: E322 H73 06)</p> <p>Solenoid valve normally closed 2/2 way valve, with manual override (For 1703 from DN 125,1303, 1403, 1503, 1706 PN 25 from DN 125) (old: E321 (H13)</p> <p>Solenoid valve universal 3/2 way valve (for 1706 PN 25 to DN 100)</p> <p>*****</p> <p>Replacement part. Diaphragm, for MV type 0610 510 001 and 0610 510 002</p> <p>Replacement part set for MV type 0610 510 001 Consisting of: Diaphragm: Armature guide tube, armature and seals</p>	<p>0610 122 084  0610 121 004  0610 132 004  0610 131 004  0610 510 002  0610 510 001  0610 133 005  *****  0610 590 001  0610 590 002</p>

<p><b>0620, 0621 Coils</b></p>		<p>AC coils with voltage indication</p> <p>DC coils with voltage indication</p>	<p>0620 xxx xxx</p> <p>0621 xxx xxx</p>
<p><b>0630 Appliance socket</b></p>		<p>Appliance socket for electromagnet</p>	<p>0630 000 000</p>
<p><b>0653 Connector modules</b></p>		<p>Connector modules for solenoid valves Type LBV 24 DC 8S, incl. 2m cable</p> <p>Connector modules for solenoid valves Type LBV IN: 48-230VAC/DC OUT: 48VDC incl. 2m cable 3-wire (Only to be used for 48VDC coils)</p>	<p>0653 024 008</p> <p>0653 230 000</p>
<p><b>0670 Overcut</b></p>		<p>AG 3/8" IG 1/8" Stainless steel AG 3/8" IG 1/4" Stainless steel AG 1/2" IG 3/8" Stainless steel AG 3/4" IG 3/8" Stainless steel AG 1" IG 1/8" Stainless steel AG 1" IG 1/2" Stainless steel</p>	<p>0670 012 004 0670 012 008 0670 016 012 0670 025 012 0670 032 012 0670 032 016</p>
<p><b>0671 Sleeve nipple reduced</b></p>		<p>IG 1/2" AG 3/8" IG 1" AG 3/8" IG 1" AG 1/2" IG 1" AG 3/4"</p>	<p>0671 016 012 0671 032 012 0671 032 016 0671 032 025</p>
<p><b>0680 Barrel nipple</b></p>		<p>AG 3/8" L = 30 mm Stainless steel AG 3/8" L = 40 mm Stainless steel AG 3/8" L = 50 mm Stainless steel AG 3/8" L = 60 mm Stainless steel AG 3/8" L = 70 mm Stainless steel AG 3/8" L = 80 mm Stainless steel AG 3/8" L = 110 mm Stainless steel AG 1/2" L = xxx mm Stainless steel</p>	<p>0680 012 030 0680 012 040 0680 012 050 0680 012 060 0680 012 070 0680 012 080 0680 012 110 0680 016 xxx</p>
<p><b>0690 Adapting nipple</b></p>		<p>AG 3/8" - 1/8" AG 3/8" - 1/4" AG 1/2" - 3/8" AG 3/4" - 3/8" AG 1" - 3/8" AG 1" - 1/2"</p>	<p>0690 012 004 0690 012 008 0690 016 012 0690 025 012 0690 032 012 0690 032 016</p>
<p><b>0711 T-fitting</b></p>		<p>IG 3/8" level Stainless steel IG 1/2" level Stainless steel IG 3/4" level Stainless steel IG 1" level Stainless steel</p>	<p>0711 012 000 0711 016 000 0711 025 000 0711 032 000</p>
<p><b>0730 Seamless tube</b></p>		<p>d6 x 1mm Stainless steel d12 x 1.5 mm Stainless steel d15 x 1.5 mm Stainless steel d18 x 1.5 mm Stainless steel</p>	<p>0730 006 010 0730 012 015 0730 015 015 0730 018 015</p>

<b>1188</b> <b>Rep. Set</b> <b>Control line</b>		From serial number 14252 (January 2003) DN40 to 100 DN125 to 300  From approx. serial number 25915 (June 2014, Filter type B (0545 112 002) DN40 to 100 DN125 to 200	1188 065 100 1188 125 300  1188 000 000 1188 000 001
<b>SA.0</b> <b>PA-tube</b>		Polyamide tube OD 6 mm, ID 4 mm Polyamide tube OD 12 mm, ID 9 mm	SA.0 000 060 SA.0 000 290

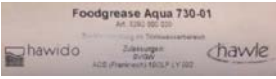
<b>Tools and accessories</b>			
<b>1199</b> <b>Spindle lifting tool</b>		M5 M6	1199 000 000 1199 000 010
<b>1199</b> <b>Spanner for sealing plate</b>		Spanner for assembling and dismantling the sealing plate from the DRV pilot valve	1199 000 020
<b>1199</b> <b>Socket spanner attachment</b>		Socket spanner attachment for flow control valve	1199 000 030
<b>1199</b> <b>Socket spanner</b>		Socket spanner for flow control valve	1199 000 040
<b>5292</b> <b>Grease</b>		Foodgrease Aqua Tube with 175g	5292 000 020

02.02.2018/plü

## E. Annex

### 1. Torques

When assembling the base valve and the control valves all **bolts** are checked with a torque spanner according to the following list. Lightly grease the bolts before assembling!

Base valve	Nominal size DN	Hex bolt M	Strength class <sup>1)</sup>	Tightening torque	
				Target	Max. <sup>2)</sup>
	40 - 50	M 8	A4/80	22 Nm	25 Nm
	65 - 80	M 10		47 Nm	50 Nm
	100	M 12		84 Nm	87 Nm
	125 - 150	M 16		172 Nm	216 Nm
	200	M 20		285 Nm	423 Nm
	250	M 20		285 Nm	423 Nm
300	M 20	380 Nm		423 Nm	

Control valve	Type	Socket M	Strength class <sup>1)</sup>	Tightening torque	
				Target	Max.
	DRV / DAV	M 6	A2 / A4 / 70	8 Nm	8.5 Nm
	MBV / RBS				
Control valve	Hex bolt M	Strength class	Tightening torque		
NAZ	M 6	A2 / A4 / 70	8 Nm	8.5 Nm	

(Not for new applications)

Base valve	Nominal size DN	Hex bolt M	Strength class <sup>1)</sup>	Tightening torque	
				Target	Max.
	40 - 50	M 8	A2/70	17 Nm	19 Nm
	65	M 10		33 Nm	36 Nm
	80	M 10		40 Nm	40 Nm
	100	M 12		70 Nm	72 Nm
	125 - 150	M 16		172 Nm	172 Nm
	200	M 20		280 Nm	285 Nm
	250	M 20		280 Nm	285 Nm
300	M 20	235 Nm		240 Nm	

Attention: <sup>1)</sup> = Note designation on screw head A2 – 70 or A4 – 80!

<sup>2)</sup> = Maximum permitted torque according to strength analysis

Bolts according to SN EN ISO 4014 and SN EN ISO 4017

As at: FO 0065, Rev. 12 / 19.12.2017

## F. Hawle in Europe

### Addresses:

Hawle Armaturen AG  
Hawlestrasse 1  
CH-8370 Sirnach  
[www.hawle.ch](http://www.hawle.ch)

telephone +41 (0)71 969 44 22  
fax +41 (0)71 969 44 11

Hawle Armaturen GmbH  
Liegnitzer Strasse 6  
D-83395 Freilassing  
[www.hawle.de](http://www.hawle.de)

telephone +49 (0)8654 63 03 - 0  
fax +49 (0)8654 63 03 60

E. Hawle Armaturenwerke GmbH  
Wagrainerstr. 13  
A-4840 Vöcklabruck  
[www.hawle.at](http://www.hawle.at)

telephone +43 (0)76 72/72 576 0  
fax +43 (0)76 72 78 464

Hawle Kft  
Dobogókoi út 5  
H-2000 Szentendre  
[www.hawle.hu](http://www.hawle.hu)

telephone +36 (0) 26 501 501  
fax +36 (0) 26 501 502

Hawle Armatury spol. s r.o.  
Ricanská 375  
CZ-25242 Jesenice u.Prahy  
[www.hawle.cz](http://www.hawle.cz)

telephone +420 (0)2 410 03 111  
fax +420 (0)2 41 00 33 33

Hawle Spółka zo.o  
ul. Piaskowa 9  
PL-62-028 Kozięglowy  
[www.hawle.pl](http://www.hawle.pl)

telephone +48 (0)61 811 14 00  
fax +48 (0)61 811 14 27

Hawle s.r.o.  
Pezinská c.30  
SK-903 01 Senec  
[www.hawle.sk](http://www.hawle.sk)

telephone +421 (0)2 45 92 21 87  
fax +421 (0)2 45 92 21 88

S.C. Hawle S.R.L.  
Calea Sagalui 104  
RO-300516 Timisoara  
[www.hawle.ro](http://www.hawle.ro)

telephone +40 268 47 78 81  
fax +40 356 80 06 68

DM Armaturen EOOD  
Ul. Lokomotiv 3  
BG-1220 Sofia  
[www.hawle.bg](http://www.hawle.bg)

telephone +359 (0)2 931 12 77  
Fax +359 2 931 04 36

Partners / Contact addresses:

---

---

---

---

28.07.2014-1/plü