

**1. Intended use**

The Hawle-BAIO® system is used primarily in drinking water supply systems (up to 16 bar). This range of fittings can also be used in municipal wastewater disposal systems (up to 10 bar) in combination with suitable gate valves (order no. 480). The information contained in these installation instructions regarding fittings, gate valves, seals and cable guards refers exclusively to their use in drinking water or wastewater systems. Please refer to the separate installation instructions when using the Hawle-BAIO® system in gas systems! GKS and BLD® seals are only approved for use in BAIO® sleeves.

During installation, it is necessary to comply with applicable standards and regulations, accident prevention regulations and regulations from trade associations. Failure to properly install the Hawle-BAIO® system may result in damage to property or personal injury.

**2. Machine description**

The Hawle-BAIO® system was developed in the early 1980s by Hawle Armaturen GmbH with the objective of providing the customer with:

- simpler installation,
- integrated tension restraint between fittings and gate valves,
- tension restraint without earthing between fitting, gate valve and pipe,
- a system for all common types of pipe (cast iron, PE, PVC, steel \*) in nominal sizes 80 to 300,
- a flangeless connection free of corrosion points,
- the connection between the spigot end and the sleeve can be angled up to 3°,
- corrosion protection thanks to an EWS coating and
- low stock-keeping

\*with ductile iron pipe outside diameter

The idea behind the Hawle-BAIO® system is based on a spigot end and sleeve connection, dimensioned from ductile iron pipe. This makes it possible for the system to connect not only with ductile iron pipes using the BAIO® lip gasket (BLD®) but also with PVC and PE pipes using the „GKS gasket“ (GKS = cast plastic gasket).



There are also welding ends for PE and steel pipes for welding to the corresponding pipe ends.

The axial restraint between the BAIO® components is produced in a form-fitting manner by means of a bayonet interlock, which is known in many technical fields.

### 3. Assembly

Before installation, the valves and fittings should be visually inspected. It is important to ensure that the coating is in perfect condition and make sure you have chosen the right seal!

The pipes are to be chamfered in accordance with regulations. An approved lubricant needs to be applied to the seals.

**Attention: When using Hawle-Stop cable restraints, no lubricant may be applied to the pipe or the clamp ring! Failure to observe the above will not guarantee that cables are protected!**

#### 3.1 Installing valves and fittings together in the BAIO® system

When combining valves and fittings, use a BAIO® lip gasket.

- Apply an approved lubricant to the BAIO® lip gasket. Make sure it is correctly seated in the sleeve!
- Insert spigot at a 45 angle offset anti-clockwise. The fixing lugs on the spigot end need to be inserted into the BAIO® sleeve's internal interlock (see Figs. 1 - 3). (The Hawle pipe-fitting device can be used for easier installation where required.) For smaller diameters, the fittings can be joined together using a mounting bar and a piece of wood (to protect the EWS coating) as shown.
- Turn the valve or fitting to the right (clockwise) (see Fig. 4)



Figure 1



Figure 2



Figure 3



Figure 4

**Attention: When locking gate valves, make sure that the valve spindle is aligned vertically. The valve spindle may not be aligned with the help of the installation kit (as there is a risk of damaging the coupling sleeve and actuating linkage).**

d) Twist lock device When installing BAIO® fittings (spigot end and sleeve connection), we generally recommend using the BAIO® unlocking device (order no. 529) to prevent subsequent unlocking of the components.

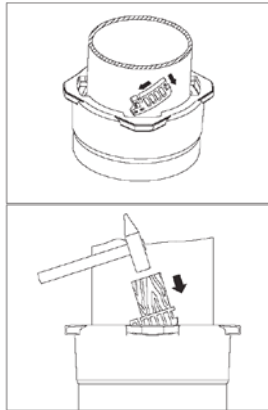

Insert the unlocking device for BAIO® fittings with the marked lugs first into one of the four recesses of the BAIO® sleeve.

Please make sure to observe the following:  
The unlocking device can only be installed after locking the spigot end in the sleeve!

If assembly is not possible using only your hands, the release lock can be hammered in using a suitable shim (made of softwood or PE block for example).

### 3.2 Installing valves in the BAIO® system in connection with various types of pipe

Depending on the type of pipe, different seals and cable strain relief guards need to be used for pipes to be fit with a tight seal and axial restraint in BAIO® sleeves.





Pipe material / component	Gasket	Axial restraint (tension restraint)
Ductile iron pipe (GGG)  Fuchs steel pipes (with outside diameter in cast iron)	BAIO® lip gasket (DN 80 - DN 300) in accordance with KTW and W270,	(Segment clamp) (Express ring)   Hawle-Stop [cast iron] BAIO®-Sit [cast iron and steel]
PE pipes: PE 80, PE 100 in accordance with DIN 8074/75 SDR 11/ 17/ 17.6  PE-X pipes in accordance with DIN 16892/93 SDR -11/ 17/ 17.6 For pipes with a very smooth surface (such as PE-X pipes), we recommend roughening the pipe end in the clamping area!	GKS (in accordance with KTW)	 (Helical toothed ring)  Hawle-Stop [PE], use support liner (order separately!)
PVC pipes in accordance with DIN 8061/8062	GKS (in accordance with KTW)	 (Corundum clamp)  Hawle-Stop [PVC]
Steel pipe tail with integrated lock ring	BAIO® lip gasket DN 80 - DN 300) in accordance with KTW and W270	
PE tail with integrated support liner and lock ring	BAIO® lip gasket DN 80 - DN 300) in accordance with KTW and W270	

Figure:



Hawle BAIO® lip gasket (BLD®)



GKS gasket

### 3.2.1 Replacing seals

**Removal:** Carefully manoeuvre a screwdriver between the BAIO® sleeve and seal without damaging the seal and EWS coating! Lift the gasket out of the sealing seat (see Fig. 5).

**Insertion:** Make sure to check the sealing seat before inserting the gasket. The insertion groove for the gasket needs be evenly coated and clean. Press the seal together to make a heart shape (see Fig. 6) and insert the seal into the BAIO® sleeve as shown in Figures 7 and 8.



Figure 5



Figure 6



Figure 7



Figure 8

Finally, check that the seal is positioned evenly over the entire circumference inside the BAIO® sleeve.



### 3.2.2 Hawle-Stop

Protecting the clamp ring from dirt, UV light and mechanical damage is absolutely critical. Before positioning the locking ring, the clamp ring needs to be positioned about 20 mm in front of the BAIO® sleeve in order to achieve a slight pre-tension of the tension restraint on the pipe to be connected. Then lock the locking ring by turning it clockwise with a rubber hammer or wooden insert on the sleeve. Improper storage can lead to loss of axial restraint! In principle, reinforcement can be used as an alternative for axial restraint.

### 3.2.3 Support liners

Support liners reduce the flow behaviour of PE pipes (PE 80, PE 100, PE-X, ...) at all joints with tension restraint. When connecting PE pipes a support liner must always be used.

### 3.2.4 Installing pipes in BAIO® sleeves

Using the Hawle pipe mounting device is recommended for pipe installation. This can be used for nominal diameters of DN 80 - DN 200! Commercially available clamping devices have also proven useful. When installing pipe, make sure that the gasket is not pushed out of the sealing seat and that the pipe is inserted as deep as possible, all the way up to the stop (exception: U fittings with no outflow). These U fittings can be pushed up against the gasket on the opposite side.

### 3.2.5 Protecting BAIO® sleeves against dirt

Using BAIO® sleeves is necessary in very loamy and fine, sandy soils, especially when laying plastic pipes with Vaseline wrap, for example, to protect against dirt, since the ingress of dirt during installation could have an adverse affect to the sealing quality. A special rubber dirt guard was developed for plastic pipes, which is inserted in the ring gap in front of the GKS gasket before pipe installation (see picture).

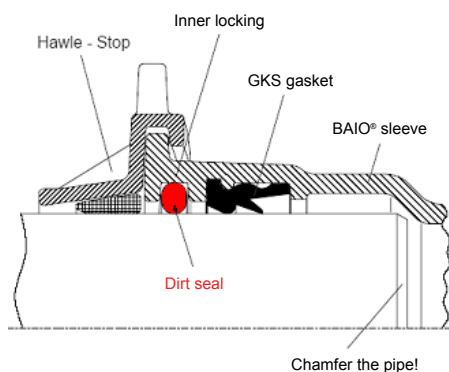

### 3.2.6 Installation of DN125/d125, DN200/d200 and DN250/d250 PE pipes in BAIO® sleeves

For the following nominal diameters, in addition to the GKS gasket, a support ring needs to be inserted into BAIO® sleeves to prevent the pipe from bending too much!

BAIO® sleeve DN in mm	Pipe exterior ø mm	Position of the support ring in the BAIO® sleeve	
125	125	behind	<p>Sleeve</p> <p>Support ring GKS gasket</p>
200	200	behind	
250	250	in front of and behind	<p>Sleeve</p> <p>Support and stop ring GKS gasket Support ring</p>

### 3.2.6 Installation of DN100/d125, DN150/d180 PE pipes in BAIO® sleeves

Connecting d125 PE pipes in DN 100 BAIO® sleeves or d180 PE pipes in DN 150 BAIO® sleeves is possible with the help of special SM fittings (order no. 532-00), which have been specially developed for this purpose. The GKS gasket is built into both of these SM fittings at the factory.

The 180 external diameter DN 150 HSM gate valve (451.150.1801) can also be used for external pipe diameters of 180. However, the spigot end of this gate valve only fits in the specially developed MMB fittings (542.150.1800, 542.180.1500, 542.180.1800).

For the sleeves, the corresponding tension restraints (order no. 528-00) must be used for PE!

### 3.3 Dirt protection and anti-rotation

Hydrants and air release valve sets with spigot ends and SM fittings in vertical installations need to be secured against unintentional unlocking. Use the dirt protection and anti-rotation device for this purpose.

- The rubber dirt protection device needs to be pushed over the locking lugs on the spigot end. The anti-rotation device then needs to be pushed over the fixing lugs and turned completely behind the fixing lugs with the snap-in cams (see Figs. 9 and 10).
- When installing the spigot end, the anti-rotation device falls into the released spaces between, thus preventing unintentional unlocking. The dirt protection then needs to be slipped over the outer lugs on the sleeve (see Fig. 11). Finally, check that the anti-rotation device functions properly.

Comment: Air release valve sets are always placed on the pipeline. Arrangements with a lateral displacement are not recommended for reasons of proper hygiene and venting.



Figure 9



Figure 10



Figure 11

### 3.4 Securing BAIO® fittings in trenches that have not been backfilled

If a trench has not been backfilled yet, all BAIO® fittings in both horizontal and vertical installations need to be secured against unlocking (tilting, twisting, etc.).

### 3.5 Special applications / fittings (the Hawle-BAIO® system for renovation of pipeline networks)

The Hawle BAIO® system is increasingly being used for the renovation of existing pipeline networks. For this purpose, the mounting sleeve piece (EMS) with threaded union, slide-on part, spigot end and the mounting sleeve piece (EMS) with WAGA Multi/Join® multi-range socket, slide-on part, spigot end must be used.



#### 3.5.1 Mounting sleeve piece (EMS) with threaded union

For installation, the threaded union is disassembled, the threaded ring, pressure ring, seal and EMS-piece are pushed over the pipe, the BAIO® fittings are mounted, the EMS-piece(s) are pushed into the BAIO®-sleeve(s) and locked. The seal and the pressure ring are then pushed into the threaded union and the threaded ring is tightened with a threaded ring key until the connection is tight.

The EMS piece with a threaded union is only suitable for ductile iron pipes.

To connect the threaded union with ductile iron pipes with full restraint, use the threaded union tension restraint (order no. 580-00).

#### 3.5.2 Mounting sleeve piece (EMS) with WAGA-Multi/Join® multirange socket

Please refer to our separate operating instructions for the EMS piece with WAGA® Multijoint multirange sleeve. These can be found at [www.hawle.de](http://www.hawle.de).

#### 3.5.3 EMS piece assembly situation

The required cut-out dimensions to be able to install the corresponding HAWLE-BAIO® system fittings and gate valves in conjunction with the EMS pieces (see points 3.5.1 and 3.5.2) can be found in the following table and drawing.

DN	EMS with threaded union		EMS with Multi/Join®		HSM
	L <sub>min</sub>	L <sub>max</sub>	L <sub>min</sub>	L <sub>max</sub>	L <sub>HSM</sub>
80	220	380	230	527	210
100	235	390	244	494	215
125	260	415	240	477	240
150	260	415	285	517	250
200	275	480	250	580	275
250	260	460	-	-	373
300	260	460	-	-	422

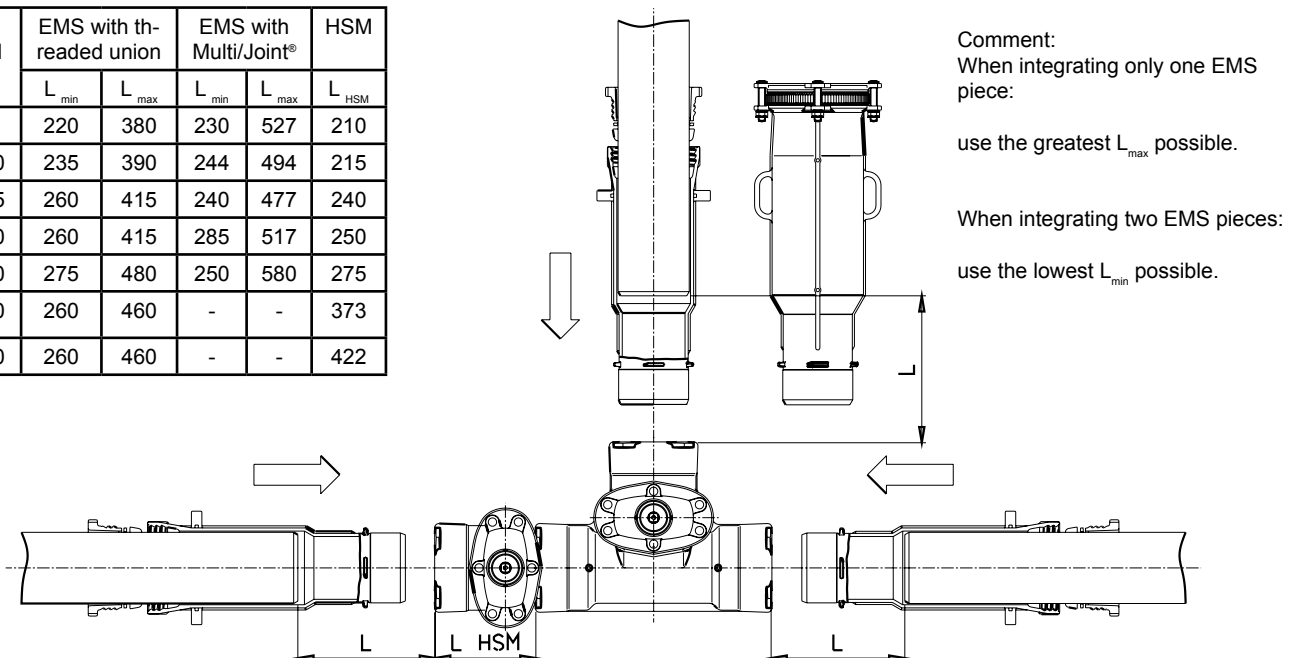

### 3.6 Transitions to nominal diameters smaller than DN 80

We recommend the HAWLE-ZAK® system for transitions to nominal diameters smaller than DN 80! The HAWLE-ZAK® system, like the HAWLE-BAIO® system, is locked with a bayonet connection between the ZAK® spigot end and the ZAK® sleeve! The transition from the BAIO® system to the ZAK® system is produced using the DN 80 BAIO® spigot end on the ZAK sleeve (ZAK46)!

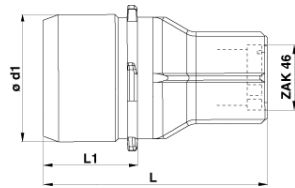

Transition piece DN 80 BAIO® spigot end to the ZAK® sleeve (ZAK46)

e.g. ZAK® spigot end with PE end

For further information on the HAWLE ZAK® system, please refer to the respective product folder that applies or the website.

### 3.7 Sealing in intersections

Special attention must be paid to the seal in intersections because of the Hawle BAIO® system's compact design. For BAIO® junctions with two or three gate valves, there are special shims (see image), designed for a nominal diameter range from DN 80 to DN 200, which reliably prevent street caps from sinking and keep all street caps at an intersection on the same level.

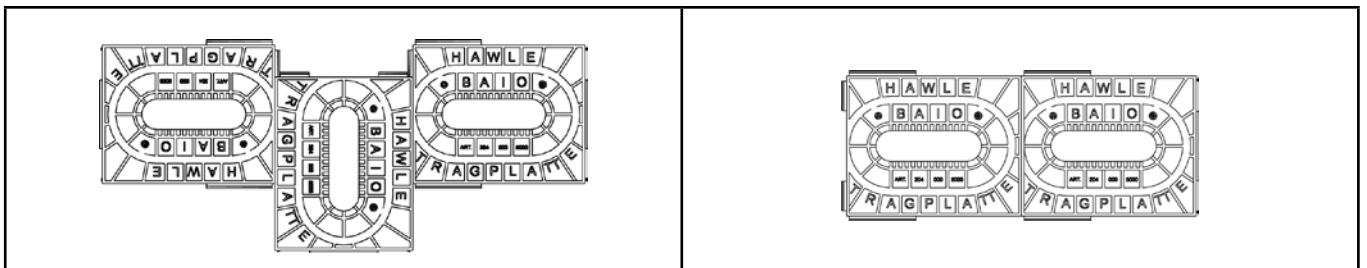

## 4. Maintenance

The Hawle-BAIO® system is maintenance-free.

Individual components such as gate valves, hydrants, ventilators, etc. should be monitored and maintained in accordance with DVGW Worksheet W 392.

## 5. Startup and pressure testing

After installation work is completed, perform a proper pressure test in accordance with the applicable rules and regulations.

Note: When testing individual sections, spigot end caps or sleeve end caps can be used.



## 5.1 Troubleshooting

Malfunction	Cause / Action
Coating is damaged	<ul style="list-style-type: none"> <li>• Repair with Hawle two-component repair kit for coatings (order no. 600 000 0010)</li> </ul>
Pipe cannot be installed	<ul style="list-style-type: none"> <li>• Is the correct seal used?</li> <li>• Chamfer pipe sufficiently, chamfer executed correctly?</li> <li>• Is the outer diameter of the pipe too big?</li> <li>• Check that the pipe is round, if necessary use rounding clamps.</li> <li>• Use the Hawle pipe mounting device (order no. 849 080 2000)</li> </ul>
BAIO® connection unsealed	<ul style="list-style-type: none"> <li>• Is the correct seal used?</li> <li>• Are there cracks in the pipe?</li> <li>• Is the pipe not fully inserted in the sleeve?</li> <li>• Is there dirt in the seal?</li> <li>• Is the seal damaged?</li> <li>• Is the outer diameter of the pipe too small?</li> </ul>
The connection does not have axial restraint (Hawle-Stop)	<ul style="list-style-type: none"> <li>• Remove lubricant in the area around the clamp ring.</li> <li>• Ductile iron pipe: Is the bitumen layer applied too thick? Remove the bitumen.</li> <li>• Was the correct clamp ring used? Replace the clamp ring.</li> <li>• Was the clamp ring used once before? Replace the clamp ring.</li> <li>• Is the clamp ring dirty? Replace the clamp ring.</li> <li>• Check the outside diameter of the pipe. Is the pipe undersized?</li> </ul>
Gate valve/fitting cannot be locked	<ul style="list-style-type: none"> <li>• Is the valve/fitting fully inserted?</li> <li>• Is the locking device dirty?</li> <li>• Is there foreign material blocking the locking device?</li> </ul>

## 5.2 References to standards and registered trademarks

“BAIO®”, BLD® “ZAK®”, “Multi/Joint®” are registered trademarks.

- DVGW worksheet W 392
- DVGW worksheet VP 545
- DVGW worksheet GW 368
- DVGW Merkblatt GW 310-1
- DIN EN 545

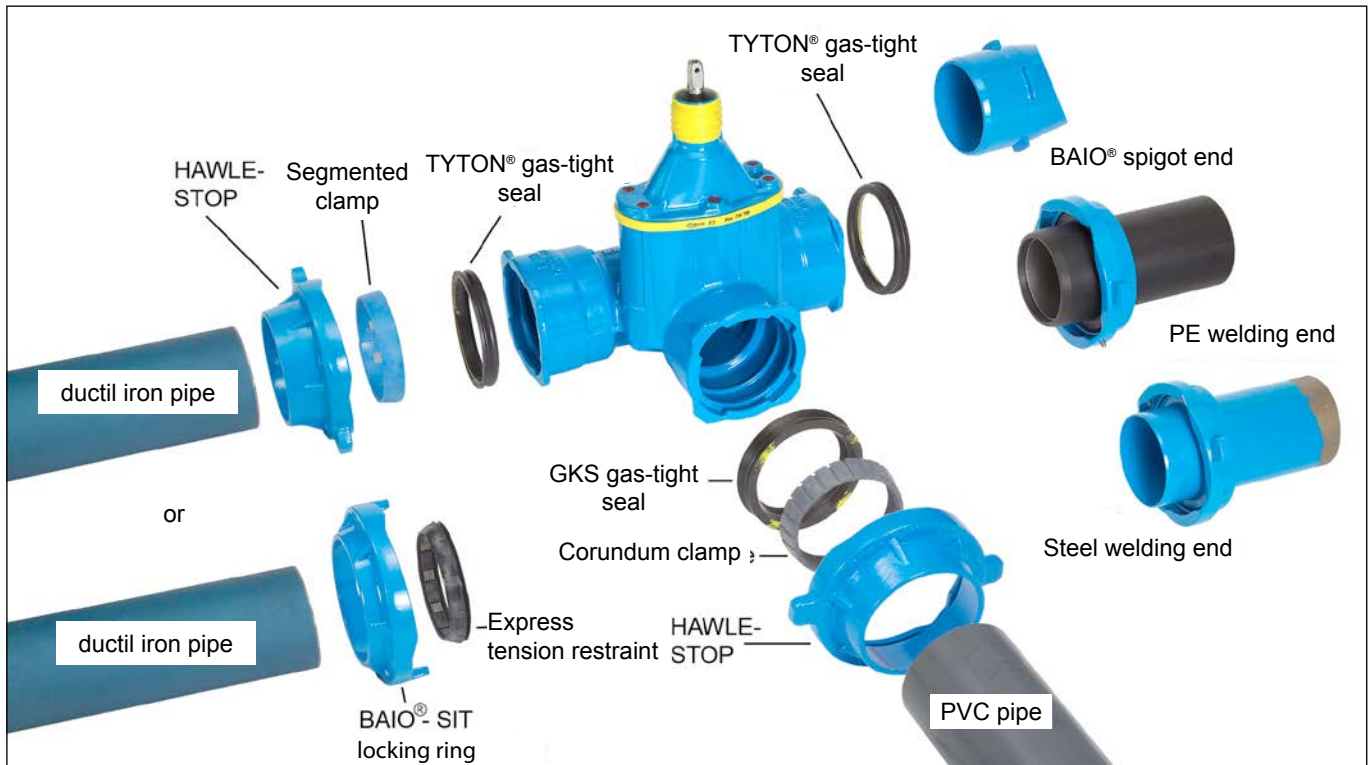
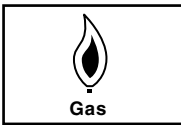

## 1. Intended use

The Hawle-BAIO® system components listed in the installation instructions can be used in gas systems with appropriate seals! The information regarding fittings, gate valves, seals and tension restraints refers exclusively to their use in gas systems.

**Please refer to the separate installation instructions when using the Hawle-BAIO® system in drinking water systems! Use in gas systems must be specified when ordering!**

**GKS gas-tight seals are only approved for use in BAIO® sleeves.**

During installation, it is necessary to comply with applicable standards and regulations, accident prevention regulations and regulations from trade associations. Failure to properly install the Hawle-BAIO® system may result in damage to property or personal injury.

Range of application depending on the connected type of pipe or moulded component:

- Ductile iron pipes (old stock only): 16 bar
- PVC pipes (old stock only): 1 bar
- PE tail (SDR 11): 10 bar (PE pipes only in connection with PE tails)
- PE tail (SDR 17): 4 bar (PE pipes only in connection with PE tails)
- Steel tails: 16 bar

## 2. Machine description

The Hawle-BAIO® system was developed in the early 1980s by Hawle Armaturen GmbH with the objective of providing the customer with:

- simpler installation,
- integrated tension restraint between fittings and gate valves,
- tension restraint without earthing between fitting, gate valve and pipe,
- a system for all common types of pipe (cast iron, PVC, PE\*, steel\*\*) in nominal sizes 80 to 300,
- a flangeless connection free of corrosion points,
- the connection between the spigot end and the sleeve can be angled up to 3°,
- corrosion protection thanks to an EWS coating and
- low stock-keeping

\*only in connection with PE tails

\*\*only in connection with steel tails

The idea behind the Hawle-BAIO® system is based on a spigot end and sleeve connection, dimensioned from ductile iron pipe. This makes it possible for the system to connect not only ductile iron pipes with standard ductile iron pipe gaskets („TY-TON®“ gas-tight), but also PVC pipes (only old stock up to 4 bar) using the „GKS gas-tight seal (GKS = cast plastic gasket).



There are also welding ends for PE and steel pipes for welding to the corresponding pipe ends. The axial restraint between the BAIO® components is produced in a form-fitting manner by means of a bayonet interlock, which is known in many technical fields.

### 3. Assembly

Before installation, the valves and fittings should be visually inspected. It is important to ensure that the coating is in perfect condition and make sure you have chosen the right seal! The pipes are to be chamfered in accordance with regulations. An approved lubricant needs to be applied to the seals.

#### Attention:

When using Hawle-Stop cable restraints, no lubricant may be applied to the pipe or the clamp ring! Failure to observe the above will not guarantee that cables are protected!

#### 3.1 Installing valves and fittings together in the BAIO® system

When combining valves and fittings, a gas-tight TYTON® gasket must always be used.

- Apply an approved lubricant to the TYTON® gasket. Make sure it is correctly seated in the sleeve!
- Insert spigot at a 45 degree offset anti-clockwise. The fixing lugs on the spigot end need to be inserted into the BAIO® sleeve's internal interlock (see Figs. 1 - 3). (The Hawle pipe-fitting device can be used for easier installation where required.) For smaller diameters, the fittings can be joined together using a mounting bar and a piece of wood (to protect the EWS coating) as shown.
- Lock the valve or fitting to the right (clockwise) (see Fig. 4)



Figure 1



Figure 2



Figure 3



Figure 4

Attention: When locking gate valves, make sure that the valve spindle is aligned vertically. The valve spindle may not be aligned with the help of the installation kit (as there is a risk of damaging the coupling sleeve and actuating linkage).

d) Twist lock device when installing BAIO® fittings (spigot end and sleeve connection) outside trenching, we recommend using the BAIO® unlocking device (order no. 529-05) to prevent subsequent unlocking of the components.

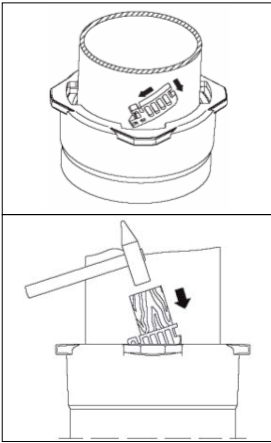





Insert the unlocking device for BAIO® fittings with the marked lugs first into one of the four recesses of the BAIO® sleeve.

Please make sure to observe the following:  
The unlocking device can only be installed after locking the spigot end in the sleeve!

If assembly is not possible using only your hands, the release lock can be hammered in using a suitable shim (made of softwood or PE block for example).

### 3.2 Installing valves in the BAIO® system in connection with various types of pipe

Depending on the type of pipe, different seals and cable strain relief guards need to be used for pipes to be fit with a tight seal and axial restraint in BAIO® sleeves.

Pipe material / component	Gasket	Axial restraint (tension restraint)
Ductile iron pipe (GGG) <b>Only for old stock!</b>  <b>Not for new installations!</b>	TYTON® gas-tight	(Segment clamp) (Express ring)  Hawle-Stop [cast iron] BAIO®-Sit [cast iron]
PVC pipes <b>Only for old stock!</b>  <b>Not for new installations!</b>	GKS gasfest	 (Corundum clamp) Hawle-Stop [PVC]
Steel pipe tail with integrated lock ring	TYTON® gas-tight	
PE tail with integrated support liner and clamping ring	TYTON® gas-tight	

#### 3.2.1 Gaskets

If installing in gas systems, this fact must be specified when ordering because special gaskets are required for gas systems!

The seals are pre-assembled at the factory. Gas seals must be marked as such. Unmarked seals must not be used in gas systems.

### 3.2.2 Hawle-Stop

Protecting the clamp ring from dirt, UV light and mechanical damage is absolutely critical. Before positioning the clamp ring, the clamping ring needs to be positioned about 20 mm in front of the BAIO® sleeve in order to achieve a slight pre-tension of the tension restraint on the pipe to be connected. Then lock the locking ring by turning it clockwise with a rubber hammer or wooden insert on the sleeve. Improper storage can lead to loss of axial restraint!



### 3.2.3 Installing pipes in BAIO® sleeves

Using the Hawle pipe mounting device is recommended for pipe installation. This can be used for nominal diameters of DN 80 - DN 200! When installing pipe, make sure that the gasket is not pushed out of the sealing seat and that the pipe is inserted as deep as possible, all the way up to the stop (exception: U fittings with no outflow). These U fittings can be pushed up against the gasket on the opposite side.

Check the correct seating of the gasket after mounting using a feeler gauge!

### 3.4 Securing BAIO® fittings in trenches that have not been backfilled

If a trench has not been backfilled yet, all BAIO® fittings in both horizontal and vertical installations need to be secured against unlocking (tilting, twisting, etc.).

### 3.5 Transitions to nominal diameters smaller than DN 80

We recommend the HAWLE-ZAK® system for transitions to nominal diameters smaller than DN 80! The HAWLE-ZAK® system, like the HAWLE-BAIO® system, is locked with a bayonet connection between the ZAK® spigot end and the ZAK® sleeve! The transition from the BAIO® system to the ZAK® system is produced using the DN 80 BAIO® spigot end on the ZAK sleeve (ZAK46)!

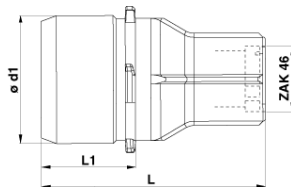

Transition piece DN 80 BAIO® spigot end to the ZAK® sleeve (ZAK46)

e.g. ZAK® spigot end with PE tail

For further information on the HAWLE ZAK® system, please refer to the respective product folder that applies or the website.

### 3.6 Sealing in intersections

Special attention must be paid to the seal in intersections because of the Hawle BAIO® system's compact design. For BAIO® junctions with two or three gate valves, there are special shims (see image), designed for a nominal diameter range from DN 80 to DN 200, which reliably prevent street caps from sinking and keep all street caps at an intersection on the same level.

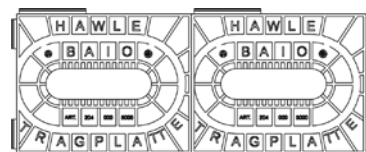
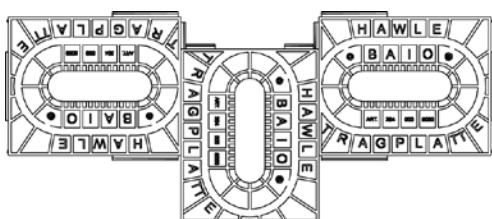



## 4. Maintenance

The Hawle-BAIO® system is maintenance-free.



## 5. Startup and pressure testing

After installation work is completed, perform a proper pressure test in accordance with the applicable rules and regulations.

Note: When testing individual sections, spigot end caps or sleeve end caps can be used.

### 5.1 Troubleshooting

Malfunction	Cause / Action
Coating is damaged	<ul style="list-style-type: none"><li>• Repair with Hawle two-component repair kit for coatings (order no. 600 000 0010). Only away from the sealing surfaces!</li></ul>
Pipe cannot be installed	<ul style="list-style-type: none"><li>• Is the correct seal used?</li><li>• Chamfer pipe sufficiently, chamfer executed correctly?</li><li>• Is the outer diameter of the pipe too big?</li><li>• Check that the pipe is round, if necessary use rounding clamps.</li><li>• Use the Hawle pipe mounting device (order no. 849 080 2000)</li></ul>
BAIO® connection unsealed	<ul style="list-style-type: none"><li>• Is the correct seal used?</li><li>• Is the pipe not fully inserted in the sleeve?</li><li>• Is there dirt in the seal?</li><li>• Is the seal damaged?</li><li>• Is the outer diameter of the pipe too small?</li></ul>
The connection does not have axial restraint (Hawle-Stop)	<ul style="list-style-type: none"><li>• Remove lubricant in the area around the clamp ring.</li><li>• Ductile iron pipe: Is the bitumen layer applied too thick? Remove the bitumen.</li><li>• Was the correct clamp ring used? Replace the clamp ring.</li><li>• Was the clamp ring used once before? Replace the clamp ring.</li><li>• Is the clamp ring dirty? Replace the clamp ring.</li><li>• Check the outside diameter of the pipe. Is the pipe undersized?</li></ul>
Gate valve/fitting cannot be locked	<ul style="list-style-type: none"><li>• Is the valve/fitting fully inserted?</li><li>• Is the locking device dirty?</li><li>• Is there foreign material blocking the locking device?</li></ul>

### 5.2 References to standards and registered trademarks

- “BAIO®“, „TYTON®“, “ZAK®“, are registered trademarks.
- DVGW worksheet VP 545
- DVGW worksheet GW 368
- DVGW Merkblatt GW 310-1
- DIN EN 969

Should you have questions or need further information, please contact:

Hawle Armaturen GmbH  
- Application Engineering -  
Liegnitzer Str. 6  
83395 Freilassing  
Phone: +49 8654 6303-0  
Fax: +49 8654 6303-222  
Email: info@hawle.de  
Web: www.hawle.de