

- FULL VERSION -



Version with flange



Version with female thread

Table of contents

1.	Intended use / product description	Page 2
2.	Installation	Page 2
3.	Commissioning and pressure testing	Page 2
3.1	Commissioning	Page 2
3.2	Pressure testing	Page 3
3.2.1	Pressure testing of the installed AV	Page 3
3.2.2	Pressure testing of pipeline	Page 3
4.	Servicing and maintenance	Page 3
4.1	Spare parts	Page 6
5.	Special functions	Page 6
5.1	Special function "Air intake only" or "Air release only" Ord. No. 987 999 2000	Page 7
5.2	Special function with outlet elbow 2" MTHR Ord. No. 987 800 1310	Page 7
	Parts list	Page 9

1. Intended use / product description

Medium: potable water
Operating range: 0,2 - 25 bar
Material: see parts list

Possible connections flange DN50, DN80
female thread 2"

The HaVent® air valve featuring the patented valve mechanism is perfectly suitable for taking in and releasing high amounts of air during filling or draining of pipelines and for releasing major amounts of air under operating pressure. With integrated ball valve for pressure relief and sample taking. Due to the high air intake capacity, the AV is additionally provided with effective vacuum protection.

Max. air release capacity: 1150 m³/h (on filling the pipeline)
Max. release cross section: 1,500 mm²
Max. cross section for in-service venting: 3.15 mm²

Product identification:

Nennweite / Size
Flansch DNxx/IG 2"
Flange 2"/female tread 2"
Druckstufe:
max. pressure
PN25
360 psi
Gehäuse/Body:
Edelstahl
stainless steel
European standard:
EN1074-4
DVGW - W
Herstelljar:
Year of manufacture:
xxx
Seriennummer:
Serial No.:
xxxxxxx
Made in Germany

During installation, assembly, and maintenance, the applicable standards and regulations, accident prevention regulations, as well as the trade associations' provisions shall be observed and complied with. Installation, assembly, and maintenance may be performed by skilled personnel only.

2. Assembly



2x open-ended wrench A/F 24 (version with flange) and A/F 70 (version with female thread)

Air valves are installed at high points, at points of change in pipe inclination, in descending line sections, in case of slightly descending or horizontal pipe runs, upstream and downstream of control valves, as well as downstream of pumps.

The outgoing outlet must be in a direct connection with the atmosphere. Any downstream line parts, e.g. for draining off splash water, must be dimensioned sufficiently large to ensure the atmospheric connection.

For detailed planning specifications for new construction and retrofitting, please refer to the technical information for planners regarding air valves and air valve sets, as well as the current DVGW sheet W 334.

The air valve / air valve set has to be installed on a vertical outlet directly on the pressure pipe. The need for an air release dome as specified in DVGW sheet W 334 has to be checked. A laterally displaced arrangement of air valves / air valve sets must be avoided.

Before installation, it must be ensured that the pressure line is free from dirt, drilling chips, or other foreign matter. If necessary, the pressure line must be flushed.

Installation shall be performed in unpressurized condition. To this end, the line must be depressurized if necessary. In a pressurized line, a shut-off element below the AV shall be closed before installation.

For installing the AV in the pipeline, the respective DVGW provisions for establishing a flanged or threaded connection shall be observed.

If exhaust air pipes are installed from the valve, care shall be taken that no water accumulating in the exhaust air pipe is able to flow back into the valve (e.g. elbows pointing downward with water drain hole at the lowest point). The exhaust air pipes must not allow any water retention caused by reduced cross sections, either.

If there is a risk of frost, the air valve must be provided on site with frost-proof insulation.

3. Commissioning and pressure testing

3.1 Commissioning

For commissioning, the unpressurized line must be filled and repressurized if required, and/or the shut-off element below the AV must be opened.

! **Important:** Acc. to DVGW W 334, the maximum filling rate must be limited to 0.25 m/s to avoid pressure surges. Before filling the pipeline, it has to be checked if the air release devices of the manholes are able to discharge the air volume.

Note: During start-up ventilation, a minor quantity of splash water is blown off via the valve.

3.2 3.2 Pressure testing

3.2.1 Pressure testing of the installed AV

Before the pipeline is subjected to a pressure test, AVs shall be put out of service. To this end, the shut-off valve below the valve must be closed.

After the successful pressure test, the shut-off valve below the AV has to be opened slowly, and the AV must be subjected to a function test and visual inspection under operating pressure.

3.2.2 Pressure testing of the pipeline

BEV's sind vor einer Druckprüfung der Rohrleitung außer Betrieb zu nehmen. Dazu ist die Absperrarmatur unterhalb des Ventils zu schließen.

Nach erfolgreicher Druckprüfung ist die Absperrarmatur unterhalb des BEV's langsam zu öffnen und das BEV einer Funktions- und Sichtprüfung unter Betriebsdruck zu unterziehen.

4. Servicing and maintenance

	Allen key A/F 6, socket wrench A/F 17 Flat-tip screwdriver blade width e.g. 3 mm, lubricant approved for potable water applications
---	--

As specified in the DVGW regulations W400-3, AVs must be maintained at least once a year. Depending on the composition of the water, it may be necessary to reduce the maintenance intervals. Regular inspection will increase the functional reliability of the AV.

For cleaning, we recommend using lukewarm water. Before reinstallation, all components shall be disinfected by means of disinfectants approved for potable water applications observing the manufacturer's instructions.



Foreign matter washed into the valve body (e.g. PE chips left over from drilling, wood, polystyrene, ...) as well as deposits (e.g. in case of ferrous or manganiferous water qualities) may impair the proper sealing function.



! **Important:** Before maintenance, AVs shall be put out of service. Maintenance shall be performed in unpressurized condition.

Important: For the sequence of dismantling and reinstallation, observe the arrow direction!

1	Slowly close the shut-off valve below the AV. For relieving the pressure of the compressed residual air in the AV, open the standard ball valve. OR Depressurize the line with the AV.
2	Any existing air intake/air exhaust piping at the AV shall also be dismantled.
3	If the AV is easily accessible, it can also be cleaned while installed on the line. If access is difficult, the AV should be dismantled completely for maintenance and cleaning work. To this end, loosen the threaded or flanged connection.

Dismantling		Reinstallation		
4	Dismantle the housing upper part (5) by loosening the five hexagon socket screws (3) using an Allen key 6 mm.	17	Tighten the hexagon socket screws (3) with shim rings (4) clockwise and handtight on the block. Then proceed with item 18!	

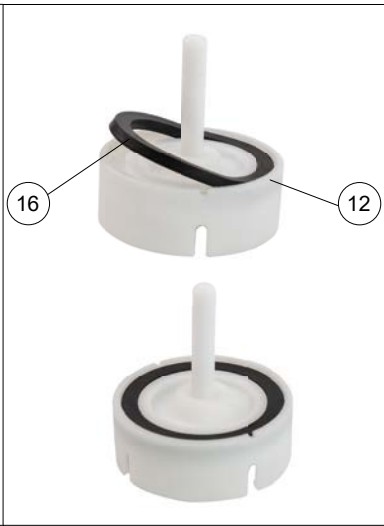
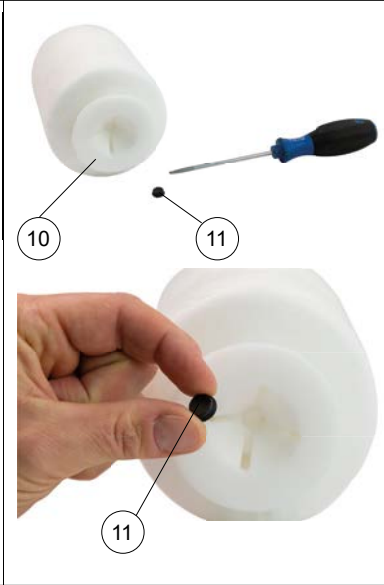
<p>5</p>	<p>Remove the housing upper part.</p> <p>Take out the float with integrated valve mechanism / function unit (9-16).</p>	<p>16</p> <p>Insert the function unit (consisting of 9-16) into the housing (1), putting the function unit onto the guide rod (8).</p> <p>Put the housing upper part with O-ring (5+2) onto the housing (1). Take care to insert the nozzle screw (15) into the central bore of the housing upper part (5).</p>	
<p>6</p>	<p>Remove any foreign matter that may be present.</p> <p>Pull the valve basket (12) off the float (9) (snap coupling).</p>	<p>15</p> <p>Ventilkorb (12) auf Schwimmer (9) aufklicken (Schnappverbindung).</p>	
	<p>If required, clean the following parts with lukewarm water:</p> <ul style="list-style-type: none"> • Housing parts • Screen of outlet elbow (7) • Gasket (11) • Nozzle (13) • Flat gasket of valve basket (16) • Cover bead (red marking) <p>Check free passage of the nozzle (13) and nozzle screw (15) and clean them, if required (see arrow Figure 3)</p> <p>Check the flat gasket (16), gasket (11), and O-ring (2) for wear and/or damage.</p> <p>If required, replace sealing elements.</p> <p>(For dismantling, see items 7-10).</p> <p>Otherwise proceed with item 15!</p>	<p>Grease the O-ring (2) with suitable lubricant.</p>	 <p>Figure 3</p>

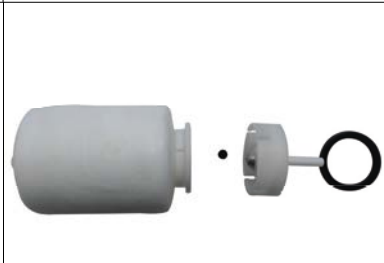
7	Lever the flat gasket (16) out of the valve basket (12) using a flat-tip screwdriver.	14 Press the tapered flat gasket (16) into the valve basket (12). Due to the tapered form, some more force will be needed for pressing in. Make sure not to damage the flat gasket.	
8	Lever the (small) gasket (11) out of the gasket seat (10) using a flat-tip screwdriver.	13 Reinsert the gasket (11) with the wide collar pointing downward.	
9	If the guide rod (8) is broken, it can be replaced. To this end, loosen the flange connection or 2" connection and dismantle the AV body from the pipeline. Subsequently, loosen nut M10 (17) using socket wrench A/F 17 and take out the defective guide rod (8).	12 Reinsert a new guide rod (8) and tighten nut M10 (10) by turning it clockwise to the block using low manual force.	
10	Figure of float with integrated valve mechanism (individual components)		
11	Reassemble the valve in reverse order (see blue instructions items 12-17).		



18	Close the drain-off fitting (ball valve).
19	Reinstall the dismantled AV on the line, if applicable.
20	Reinstall any existing air intake/air exhaust piping on the AV.
21	Slowly open the shut-off valve and/or repressurize the line with the AV.
22	After maintenance, a visual inspection for leak tightness and function must be performed. Important: If the valve does not seal reliably and tightly, maintenance must be repeated. Commissioning and pressure testing see item 3.

4.1 Spare parts

	
 O-ring 116x4 Art.No. 992 299 0033 Ord.No. 009E01	 Function unit PN25 Art. No. 987 800 0026 Ord. No. 987E00

Other spare parts on request.

5.Special functions



All special functions are available ex factory or can be retrofitted on site, if required. Maintenance is carried out the same way as described for the standard version (see item 4).

5.1 Special function “Air intake only” or “Air release only” Ord. No. 987 999 2000

Special function “Air intake only”: e.g. to avoid a vacuum when the air release function is inhibited

Special function “Air release only”: e.g. upstream of medium-controlled control valves; no dirt can be sucked in.

Description for retrofitting:



1.	Figure of conversion kit consisting of outlet elbow 2” MTHR and check valve.	
2.	Dismantle the original outlet elbow manually by turning it counterclockwise.	

3.	<p>Install the conversion kit including the original outlet elbow as depicted.</p> <p>Install all components manually by turning them clockwise. No sealing required.</p> <p>Observe the mounting direction of the check valve.</p>	
----	---	--

5.2 Special function with outlet elbow 2" MTHR Ord. No. 987 800 1310

Outlet elbow 2" MTHR for connection to a blow-off pipe or, e.g., a check valve

Description for retrofitting:

1.	Figure of outlet elbow	
2.	Dismantle the original outlet elbow manually by turning it counterclockwise.	
3.	Install the outlet elbow manually by turning it clockwise. No sealing required.	

If you have any other questions or if you need more information, please contact:

Hawle Armaturen GmbH
 - Application Engineering -
 Liegnitzer Str. 6
 D - 83395 Freilassing
 Phone: +49 (0)8654 6303-0
 Telefax: +49 (0)8654 6303-222
 E-Mail: info@hawle.de
 Web: www.hawle.de

HaVent® Air valve for potable water PN 25

Parts list

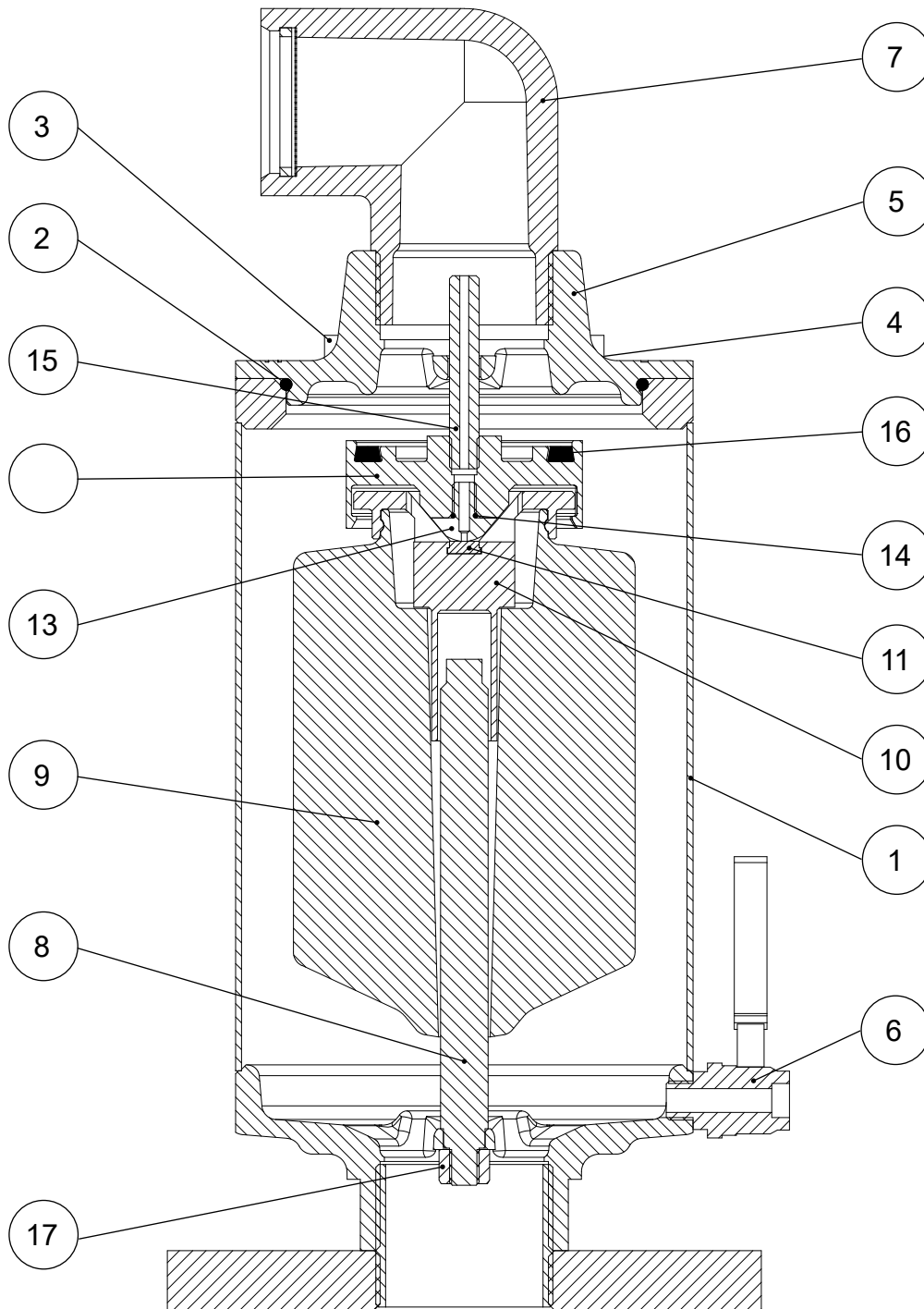

No	Qty.	Short description	Material
1	1	Housing	Stainless steel
2	1	O-ring	EPDM
3	5	Hexagon socket screw	Stainless steel
4	5	Shim ring	Stainless steel
5	1	Housing upper part	Stainless steel
6	1	Ball valve 1/4" FTMR-MTHR	Ms

8	1	Guide rod PN25	1.4301
9	1	Float	PP
10	1	Gasket seat	POM
11	1	Small Gasket	EPDM
12	1	Valve basket PN25	POM
13	1	Nozzle PN 25	Stainless steel
14	1	O-ring 6x1,5	EPDM
15	1	Nozzle screw	POM
16	1	Flat gasket	EPDM
17	1	Nut M10	Stainless steel