

1. Intended use:

The Hawle R1 standpost hydrant is suitable for water applications acc. to EN 14384 up to a max. operating pressure of 16 bar.

During installation and maintenance work the installation instructions shall be complied with, and besides the applicable standards and guidelines, the accident prevention regulations as well as the regulations of the employers' liability insurance association as well as for CE marking.

2. Product description:

Hawle standpost hydrants are made exclusively of high-grade and non-corroding materials. The choice of materials ensures high functionality and consistently good appearance in all environmental situations (salt spreading, industrial areas, coastal regions).

The shut-off function of the R1 hydrant is performed by a ring cylinder of stainless steel with cured-on sealing. This ensures extremely low operating forces on opening and closing the hydrant even in case of high line pressure.

Another advantage is afforded by the hydrant head and the standpipe. To align the outlets, the hydrant head can be turned to each intermediate position from 0° to 360° even when installed. The standpipe can be aligned independently of the head.

The predetermined breaking point ensures that the closed hydrant remains tightly closed in case of an accident. Spare screws for quick repair are accommodated below the operating cap.

There are some more advantages in terms of storage, transportation and installation. The materials used have a considerably lower weight than conventional standpost hydrants of cast iron.

2.1 models

<p>516</p> <p>R1 breakaway hydrant Outlets: 2 x B + 2 x A</p>	<p>518</p> <p>R1 breakaway hydrant with drop-down cover Outlets: 2 x B + 2 x A</p>	<p>516</p> <p>R1 breakaway hydrant Outlets: 2 x B + 1 x A</p>	<p>518</p> <p>R1 breakaway hydrant with drop-down cover Outlets: 2 x B + 1 x A</p>
---	--	---	--

3. Assembly

3.1 Installation



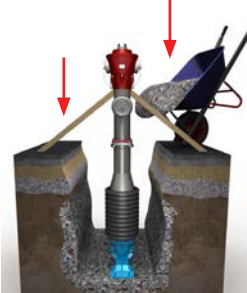
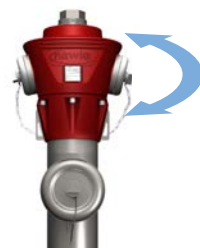

<p>1</p>	<p>Prepare a foundation for the hydrant base in the pit. Put the hydrant on the foundation and align it vertically. Acc. to DVGW-VP 325: 01-2008 the predetermined breaking point should be situated approx. 120 mm (+/-80) above ground level.</p>	<p>2</p>	<p>Support the hydrant base sufficiently against the soil.</p> <p><u>Please note:</u> If the soil is too soft the breakaway hydrant may be displaced before the predetermined breaking point yields!</p>
<p>3</p>	<p>For maintenance work we recommend the installation of a gate valve in the branch pipe to the hydrant.</p> <p>Connect the main line.</p>	<p>4</p>	<p>The hydrant should be surrounded by a seeping water drain packing. Drainage is effected via four drain-off pipes.</p>

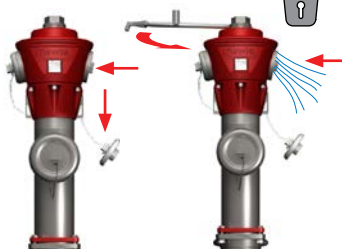
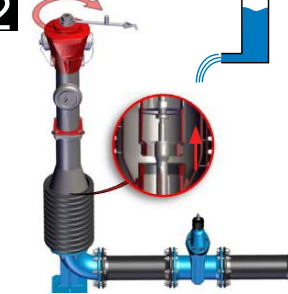
<p>5</p>  <p>Fill the pit and compact the soil. Below the predetermined breaking point, support the hydrant sufficiently against the soil.</p>	<p>6</p>  <p>If required, turn the hydrant head to the desired position. Please note: Work at the hydrant head only with closed hydrant shut-off device or gate valve in the supply line! For turning the hydrant head loosen the hexagon socket screw below the head. Turn the head to the desired position. Retighten hexagon socket screws (max. tightening torque 55 Nm). Flush the hydrant and check free movement.</p>
--	--



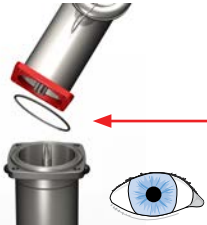



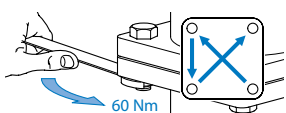
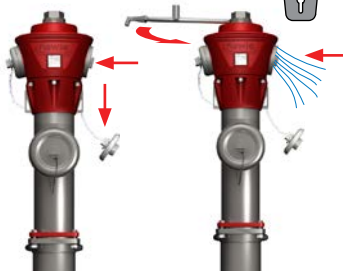
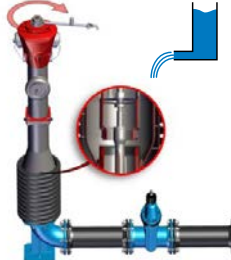



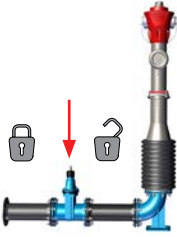
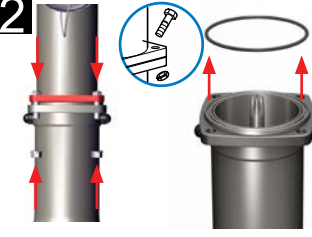

3.2 Annual inspection

<p>1</p>  <p>Remove the cap for coupling B and/or A. Subsequently open and flush the hydrant. Open the hydrant completely by turning the operating cap counterclockwise. Withdrawal may be regulated only through connected shut-off valves.</p>	<p>2</p>  <p>Close the hydrant after operation. Check the drain-off function. If the hydrant doesn't drain after a waiting period of four to five minutes, the clogged drain-off bore has to be flushed free by means of a hand pump, for example. Mount the cap for coupling A and/or B.</p>
--	--

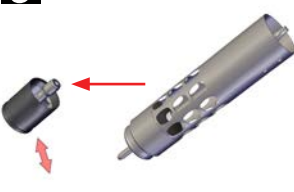
3.3 Breakage of the predetermined breaking point (Ord. No. 517 and 519):

<p>1</p>  <p>Visual check for damage or dirt at or in the hydrant. Dispose of partially fractured or broken break bolts.</p>	<p>2</p>  <p>Reinsert the centring gasket where required.</p>
<p>3</p>  <p>Take the spare screws from the screw holder below the hood of the hydrant head. Procure spare screws (Ord. No. 519 000 0004) from Hawle and place them in the hydrant head.</p>	<p>4</p>  <p>Put on the standpost and take care that the spindle coupling box glides over the spindle square.</p>
<p>5</p>  <p>Tighten the break bolts crosswise. Tightening torque 60 Nm</p>	<p>6</p>  <p>Remove the cap for coupling B and/or A. Subsequently open and flush the hydrant. Withdrawal may be regulated only through connected shut-off valves.</p>
<p>7</p>  <p>Close the hydrant and check the drain-off function. Mount the cap for coupling B and/or A.</p>	

3.4 Exchanging the shut-off ring cylinder:

	<p>1 Close the supply line to the hydrant. Close the hydrant and turn it back by approx. half a turn.</p>		<p>2 Screw the hydrant apart at the predetermined breaking point. Remove the centring gasket.</p>
	<p>3 Pull off the screw caps, unscrew and remove the holding screws.</p>		<p>4 After removing the holding screws the internal equipment is unscrewed and removed via approx. 5 spindle turns so that the installation holes of the internal equipment are flush with the holes of the external housing.</p>
	<p>5 Then the unscrewed internal equipment is screwed again with the external housing at the installation holes (use holding screws).</p>		<p>6 The shut-off ring cylinder is still in the valve seat. Turn the shut-off body out of the valve seat through approx. 5 clockwise turns.</p>
	<p>7 Then loosen the holding screws and pull the internal equipment out of the housing.</p>		<p>8 Loosen the internal equipment from the shut-off ring cylinder by turning it counterclockwise and take it off.</p>
	<p>9 Exchange the shut-off ring cylinder.</p>		<p>10 Screw the shut-off ring cylinder to the internal equipment by turning it clockwise. <u>Please note:</u> Apply some fitting grease to the rubber surface of the shut-off ring cylinder!</p>
	<p>11 Subsequently the internal equipment with the screwed-on shut-off ring cylinder is inserted into the housing. The internal equipment has to be screwed with the external housing at the installation holes.</p>		<p>12 Screw the shut-off ring cylinder into the valve seat via approx. 5 counterclockwise turns.</p>
	<p>13 Then loosen and remove the holding screws. Screw in the internal equipment via approx. 5 turns so that the fixing holes of the internal equipment are flush with the holes of the external housing.</p>		<p>14 Re-insert the holding screws in the bores of the housing provided for this purpose and screw them with the internal equipment. Please note: check gaskets (6.1.3) for damage. To protect the screws put the screw caps back onto the screws.</p>

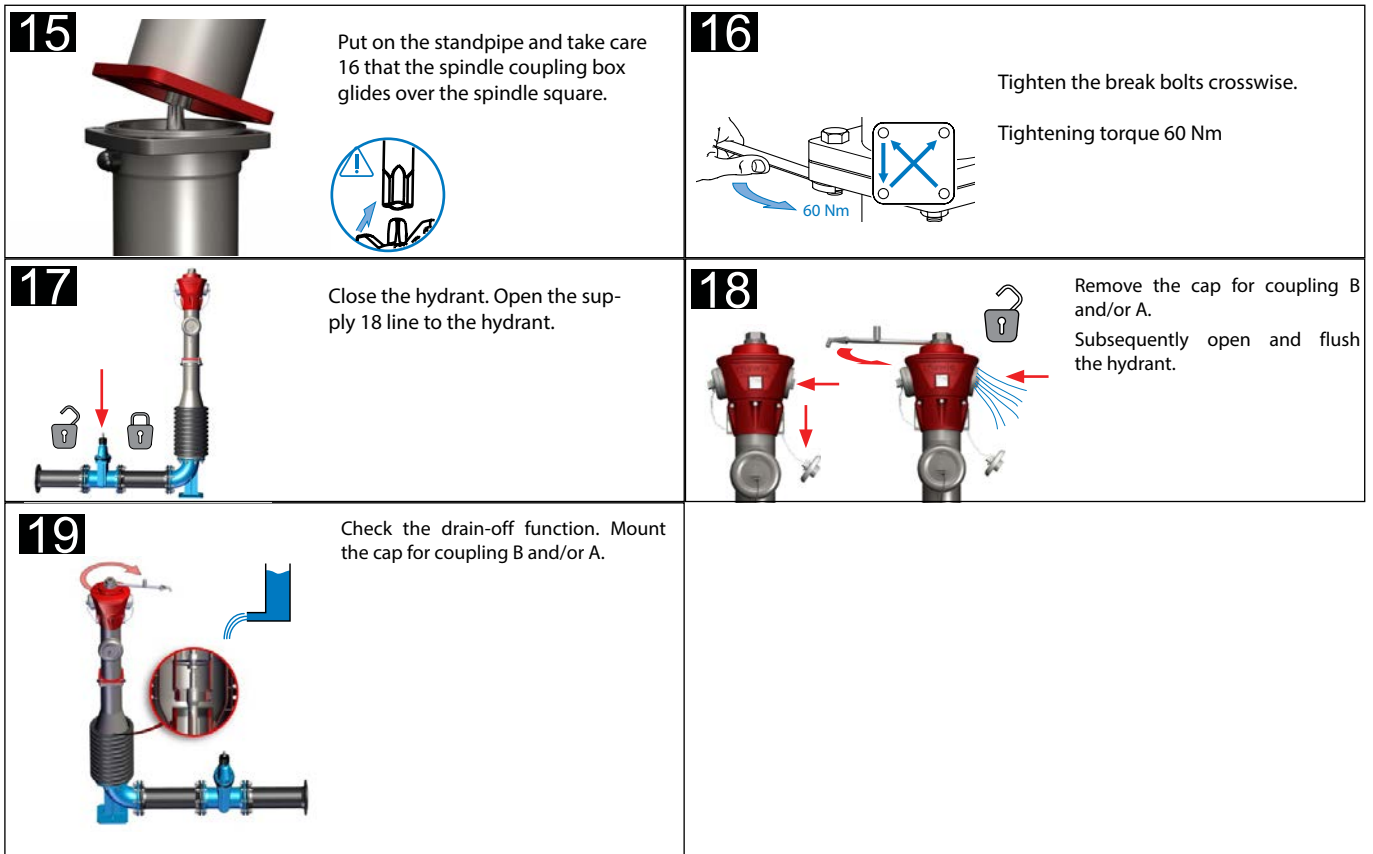

4. Start-up and pressure testing:

After connecting the hydrant to the mains system a leakage test shall be performed in the open trench acc. to the DVGW regulations. During this process the hydrant shall be fixed in the trench.

After the leakage test a function check has to be performed.

5. Servicing and maintenance:

Hawle standpost hydrants require little maintenance.

Acc. to DVGW sheet W331 (selection, installation and operation of hydrants), version January 2006, visual and functional checks and the resultant maintenance work at hydrants shall be performed at regular intervals by instructed personnel only.

For information on inspection and maintenance work please refer also to DVGW sheet S392-2.

Exploded view of standpost hydrant, Ord. No. 516

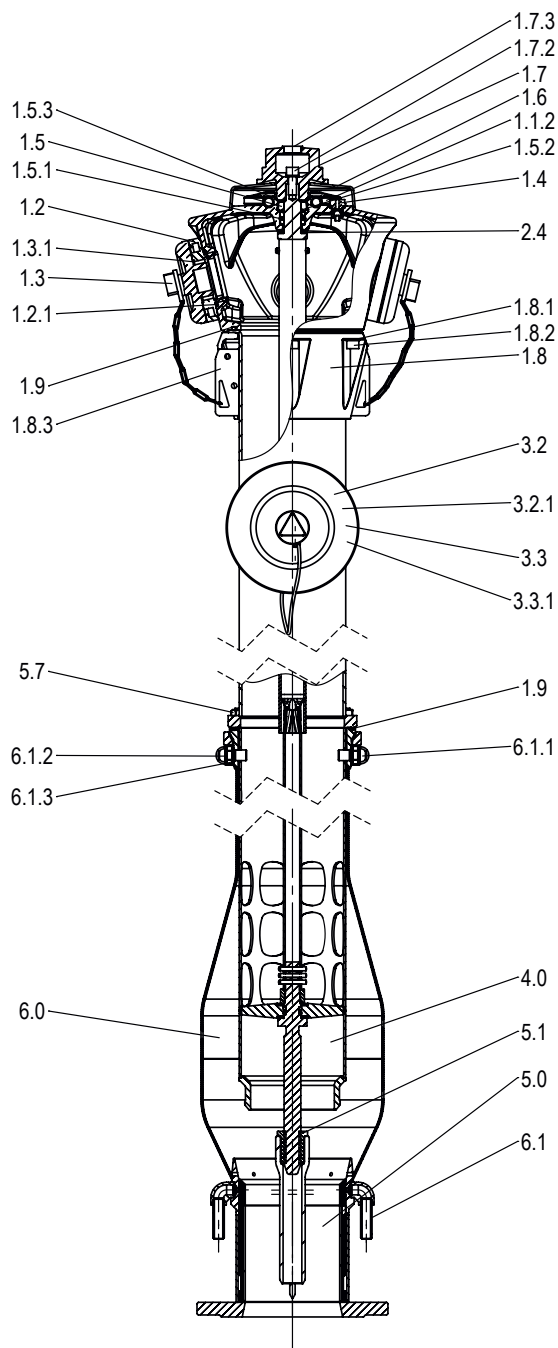

Pos:	Designation
1.1.2	screw holder
1.2	fixed coupling B
1.2.1	o-ring for coupling B
1.3	cap for coupling B
1.3.1	gasket for coupling B
1.4	ventilation valve
1.5	o-ring carrier
1.5.1	o-ring
1.5.2	o-ring
1.5.3	friction washer
1.6	hood
1.7	operating cap
1.7.2	allen screw
1.7.3	gasket plug
1.8	lock ring
1.8.1	washer
1.8.2	allen screw
1.8.3	fixing lug
1.9	centring gasket
2.4	friction washer
3.2	fixed coupling A
3.2.1	o-ring for coupling A
3.3	cap for coupling A
3.3.1	gasket for coupling A
4.0	internal equipment
5.0	shut-off ring cylinder
5.1	spindle nut
6.0	housing
6.1	drain-off pipe
6.1.1	screw caps
6.1.2	holding screw
6.1.3	gasket washer

If you have any more questions or need more detailed information, please don't hesitate to contact us:

Hawle Armaturen GmbH
 - Anwendungstechnik -
 Liegnitzer Str. 6
 83395 Freilassing
 Phone: +49 (0)8654 6303-0
 Telefax: +49 (0)8654 6303-222
 E-Mail: anwendungstechnik@hawle.de
 Internet: www.hawle.de